

LVM Administrator's Guide

5.1

Configuration and Administration

ISBN: N/A

Publication date:

LVM Administrator's Guide

This book describes the LVM logical volume manager, including information on running LVM in a clustered environment. The content of this document is specific to the LVM2 release.



LVM Administrator's Guide: Configuration and Administration

Copyright © 2007 Red Hat, Inc.

Copyright © 2007 by Red Hat, Inc. This material may be distributed only subject to the terms and conditions set forth in the Open Publication License, V1.0 or later (the latest version is presently available at <http://www.opencontent.org/openpub/>).

Distribution of substantively modified versions of this document is prohibited without the explicit permission of the copyright holder.

Distribution of the work or derivative of the work in any standard (paper) book form for commercial purposes is prohibited unless prior permission is obtained from the copyright holder.

Red Hat and the Red Hat "Shadow Man" logo are registered trademarks of Red Hat, Inc. in the United States and other countries.

All other trademarks referenced herein are the property of their respective owners.

The GPG fingerprint of the security@redhat.com key is:

CA 20 86 86 2B D6 9D FC 65 F6 EC C4 21 91 80 CD DB 42 A6 0E

1801 Varsity Drive
Raleigh, NC 27606-2072
USA
Phone: +1 919 754 3700
Phone: 888 733 4281
Fax: +1 919 754 3701
PO Box 13588
Research Triangle Park, NC 27709
USA

Introduction	ix
1. About This Guide	ix
2. Audience	ix
3. Software Versions	ix
4. Related Documentation	ix
5. Feedback	x
6. Document Conventions	xi
1. The LVM Logical Volume Manager	1
1. Logical Volumes	1
2. LVM Architecture Overview	2
3. Running LVM in a Cluster	3
4. Document Overview	5
2. LVM Components	7
1. Physical Volumes	7
1.1. LVM Physical Volume Layout	7
1.2. Multiple Partitions on a Disk	8
2. Volume Groups	9
3. LVM Logical Volumes	9
3.1. Linear Volumes	9
3.2. Striped Logical Volumes	12
3.3. Mirrored Logical Volumes	14
3.4. Snapshot Volumes	15
3. LVM Administration Overview	17
1. Creating LVM Volumes in a Cluster	17
2. Logical Volume Creation Overview	17
3. Growing a File System on a Logical Volume	18
4. Logical Volume Backup	18
5. Logging	19
4. LVM Administration with CLI Commands	21
1. Using CLI Commands	21
2. Physical Volume Administration	23
2.1. Creating Physical Volumes	23
2.2. Displaying Physical Volumes	25
2.3. Preventing Allocation on a Physical Volume	26
2.4. Resizing a Physical Volume	26
2.5. Removing Physical Volumes	26
3. Volume Group Administration	27
3.1. Creating Volume Groups	27
3.2. Adding Physical Volumes to a Volume Group	28

3.3. Displaying Volume Groups	28
3.4. Scanning Disks for Volume Groups to Build the Cache File	30
3.5. Removing Physical Volumes from a Volume Group	30
3.6. Changing the Parameters of a Volume Group	31
3.7. Activating and Deactivating Volume Groups	31
3.8. Removing Volume Groups	32
3.9. Splitting a Volume Group	32
3.10. Combining Volume Groups	33
3.11. Backing Up Volume Group Metadata	33
3.12. Renaming a Volume Group	33
3.13. Moving a Volume Group to Another System	34
3.14. Recreating a Volume Group Directory	35
4. Logical Volume Administration	35
4.1. Creating Logical Volumes	35
4.2. Persistent Device Numbers	41
4.3. Resizing Logical Volumes	41
4.4. Changing the Parameters of a Logical Volume Group	41
4.5. Renaming Logical Volumes	42
4.6. Removing Logical Volumes	42
4.7. Displaying Logical Volumes	43
4.8. Growing Logical Volumes	43
4.9. Extending a Striped Volume	45
4.10. Shrinking Logical Volumes	47
5. Creating Snapshot Volumes	47
6. Controlling LVM Device Scans with Filters	49
7. Online Data Relocation	50
8. Activating Logical Volumes on Individual Nodes in a Cluster	51
9. Customized Reporting for LVM	51
9.1. Format Control	52
9.2. Object Selection	55
9.3. Sorting LVM Reports	63
9.4. Specifying Units	64
5. LVM Configuration Examples	67
1. Creating an LVM Logical Volume on Three Disks	67
1.1. Creating the Physical Volumes	67
1.2. Creating the Volume Group	67
1.3. Creating the Logical Volume	68
1.4. Creating the File System	68
2. Creating a Striped Logical Volume	69
2.1. Creating the Physical Volumes	69

2.2. Creating the Volume Group	69
2.3. Creating the Logical Volume	69
2.4. Creating the File System	70
3. Splitting a Volume Group	71
3.1. Determining Free Space	71
3.2. Moving the Data	71
3.3. Splitting the Volume Group	72
3.4. Creating the New Logical Volume	72
3.5. Making a File System and Mounting the New Logical Volume ..	73
3.6. Activating and Mounting the Original Logical Volume	73
4. Removing a Disk from a Logical Volume	74
4.1. Moving Extents to Existing Physical Volumes	74
4.2. Moving Extents to a New Disk	75
6. LVM Troubleshooting	79
1. Troubleshooting Diagnostics	79
2. Displaying Information on Failed Devices	79
3. Recovering from LVM Mirror Failure	81
4. Recovering Physical Volume Metadata	85
5. Replacing a Missing Physical Volume	87
6. Removing Lost Physical Volumes from a Volume Group	87
7. Insufficient Free Extents for a Logical Volume	88
7. LVM Administration with the LVM GUI	91
A. The Device Mapper	93
B. The LVM Configuration Files	95
1. The LVM Configuration Files	95
2. Sample lvm.conf File	96
C. LVM Object Tags	105
1. Adding and Removing Object Tags	105
2. Host Tags	105
3. Controlling Activation with Tags	106
D. LVM Volume Group Metadata	109
1. The Physical Volume Label	109
2. Metadata Contents	110
3. Sample Metadata	111
Index	115

Introduction

1. About This Guide

This book describes the Logical Volume Manager (LVM), including information on running LVM in a clustered environment. The content of this document is specific to the LVM2 release.

2. Audience

This book is intended to be used by system administrators managing systems running the Linux operating system. It requires familiarity with Red Hat Enterprise Linux 5 and GFS file system administration.

3. Software Versions

Software	Description
RHEL5	refers to RHEL5 and higher
GFS	refers to GFS for RHEL5 and higher

Table 1. Software Versions

4. Related Documentation

For more information about using Red Hat Enterprise Linux, refer to the following resources:

- Red Hat Enterprise Linux Installation Guide — Provides information regarding installation of Red Hat Enterprise Linux 5.
- Red Hat Enterprise Linux Deployment Guide — Provides information regarding the deployment, configuration and administration of Red Hat Enterprise Linux 5.

For more information about Red Hat Cluster Suite for Red Hat Enterprise Linux 5, refer to the following resources:

Introduction

- Red Hat Cluster Suite Overview — Provides a high level overview of the Red Hat Cluster Suite.
- Configuring and Managing a Red Hat Cluster — Provides information about installing, configuring and managing Red Hat Cluster components.
- Global File System: Configuration and Administration — Provides information about installing, configuring, and maintaining Red Hat GFS (Red Hat Global File System).
- Using Device-Mapper Multipath — Provides information about using the Device-Mapper Multipath feature of Red Hat Enterprise Linux 5.
- Using GNBD with Global File System — Provides an overview on using Global Network Block Device (GNBD) with Red Hat GFS.
- Linux Virtual Server Administration — Provides information on configuring high-performance systems and services with the Linux Virtual Server (LVS).
- Red Hat Cluster Suite Release Notes — Provides information about the current release of Red Hat Cluster Suite.

Red Hat Cluster Suite documentation and other Red Hat documents are available in HTML, PDF, and RPM versions on the Red Hat Enterprise Linux Documentation CD and online at <http://www.redhat.com/docs/>.

5. Feedback

If you spot a typo, or if you have thought of a way to make this manual better, we would love to hear from you. Please submit a report in Bugzilla (<http://bugzilla.redhat.com/bugzilla/>) against the component rh-cs.

Be sure to mention the manual's identifier:

```
rh-clvm(EN)-5.1 (2007-10-30T15:15)
```

By mentioning this manual's identifier, we know exactly which version of the guide you have.

If you have a suggestion for improving the documentation, try to be as specific as possible. If you have found an error, please include the section number and some of the surrounding text so we can find it easily.

6. Document Conventions

Certain words in this manual are represented in different fonts, styles, and weights. This highlighting indicates that the word is part of a specific category. The categories include the following:

Courier font

Courier font represents commands, file names and paths, and prompts .

When shown as below, it indicates computer output:

```
Desktop  about.html  logs  paulwesterberg.png
Mail     backupfiles  mail  reports
```

bold Courier font

Bold Courier font represents text that you are to type, such as: **service jonas start**

If you have to run a command as root, the root prompt (#) precedes the command:

```
# gconftool-2
```

italic Courier font

Italic Courier font represents a variable, such as an installation directory:
install_dir/bin/

bold font

Bold font represents **application programs** and **text found on a graphical interface**.

When shown like this: **OK** , it indicates a button on a graphical application interface.

Additionally, the manual uses different strategies to draw your attention to pieces of information. In order of how critical the information is to you, these items are marked as follows:



Note

A note is typically information that you need to understand the behavior of the system.



Tip

A tip is typically an alternative way of performing a task.



Important

Important information is necessary, but possibly unexpected, such as a configuration change that will not persist after a reboot.



Caution

A caution indicates an act that would violate your support agreement, such as recompiling the kernel.



Warning

A warning indicates potential data loss, as may happen when tuning hardware for maximum performance.

The LVM Logical Volume Manager

This chapter provides a high-level overview of the components of the Logical Volume Manager (LVM).

1. Logical Volumes

Volume management creates a layer of abstraction over physical storage, allowing you to create logical storage volumes. This provides much greater flexibility in a number of ways than using physical storage directly.

A logical volume provides storage virtualization. With a logical volume, you are not restricted to physical disk sizes. In addition, the hardware storage configuration is hidden from the software so it can be resized and moved without stopping applications or unmounting file systems. This can reduce operational costs.

Logical volumes provide the following advantages over using physical storage directly:

- Flexible capacity

When using logical volumes, file systems can extend across multiple disks, since you can aggregate disks and partitions into a single logical volume.

- Resizeable storage pools

You can extend logical volumes or reduce logical volumes in size with simple software commands, without reformatting and repartitioning the underlying disk devices.

- Online data relocation

To deploy newer, faster, or more resilient storage subsystems, you can move data while your system is active. Data can be rearranged on disks while the disks are in use. For example, you can empty a hot-swappable disk before removing it.

- Convenient device naming

Logical storage volumes can be managed in user-defined groups, which you can name according to your convenience.

- Disk striping

You can create a logical volume that stripes data across two or more disks. This can dramatically increase throughput.

- Mirroring volumes

Logical volumes provide a convenient way to configure a mirror for your data.

- Volume Snapshots

Using logical volumes, you can take device snapshots for consistent backups or to test the effect of changes without affecting the real data.

The implementation of these features in LVM is described in the remainder of this document.

2. LVM Architecture Overview

For the RHEL 4 release of the Linux operating system, the original LVM1 logical volume manager was replaced by LVM2, which has a more generic kernel framework than LVM1. LVM2 provides the following improvements over LVM1:

- flexible capacity
- more efficient metadata storage
- better recovery format
- new ASCII metadata format
- atomic changes to metadata
- redundant copies of metadata

LVM2 is backwards compatible with LVM1, with the exception of snapshot and cluster support. You can convert a volume group from LVM1 format to LVM2 format with the `vgconvert` command. For information on converting LVM metadata format, see the `vgconvert(8)` man page.

The underlying physical storage unit of an LVM logical volume is a block device such as a partition or whole disk. This device is initialized as an LVM physical volume (PV).

To create an LVM logical volume, the physical volumes are combined into a volume group (VG). This creates a pool of disk space out of which LVM logical volumes (LVs) can be allocated. This process is analogous to the way in which disks are divided into partitions. A logical volume is used by file systems and applications (such as databases).

Figure 1.1, “LVM Logical Volume Components” shows the components of a simple LVM logical volume:

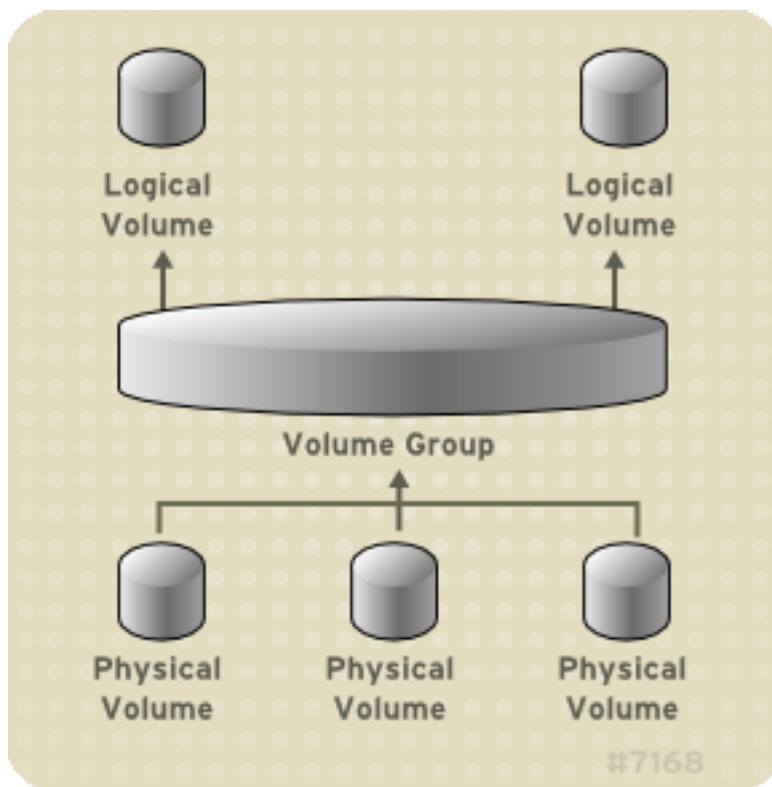

Figure 1.1. LVM Logical Volume Components

For detailed information on the components of an LVM logical volume, see [Chapter 2, LVM Components](#).

3. Running LVM in a Cluster

The Clustered Logical Volume Manager (CLVM) is a set of clustering extensions to LVM. These extensions allow a cluster of computers to manage shared storage (for example, on a SAN) using LVM.

The `clmvd` daemon is the key clustering extension to LVM. The `clmvd` daemon runs in

each cluster computer and distributes LVM metadata updates in a cluster, presenting each cluster computer with the same view of the logical volumes.

Figure 1.2, “CLVM Overview” shows a CLVM overview in a Red Hat cluster.

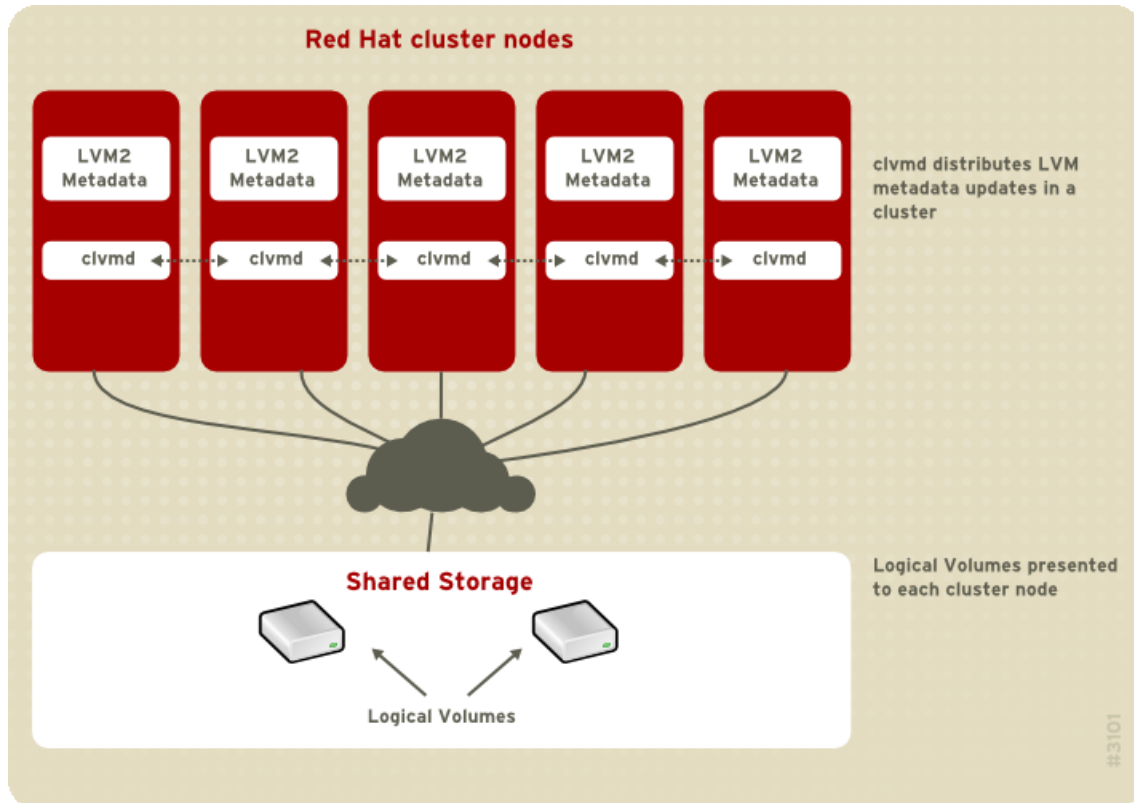

Figure 1.2. CLVM Overview

Logical volumes created with CLVM on shared storage are visible to all computers that have access to the shared storage.

CLVM allows a user to configure logical volumes on shared storage by locking access to physical storage while a logical volume is being configured. CLVM uses the locking services provided by the high availability symmetric infrastructure.



Note

CLVM requires changes to the `lvm.conf` file for cluster-wide locking. For information on configuring the `lvm.conf` file to support CLVM, see Section 1, “Creating LVM Volumes in a Cluster”.

You configure LVM volumes for use in a cluster with the standard set of LVM commands or the LVM graphical user interface, as described in [Chapter 4, LVM Administration with CLI Commands](#) and [Chapter 7, LVM Administration with the LVM GUI](#).

For information on installing LVM in a Red Hat Cluster, see [Configuring and Managing a Red Hat Cluster](#).

4. Document Overview

This remainder of this document includes the following chapters:

- [Chapter 2, LVM Components](#) describes the components that make up an LVM logical volume.
- [Chapter 3, LVM Administration Overview](#) provides an overview of the basic steps you perform to configure LVM logical volumes, whether you are using the LVM Command Line Interface (CLI) commands or the LVM Graphical User Interface (GUI).
- [Chapter 4, LVM Administration with CLI Commands](#) summarizes the individual administrative tasks you can perform with the LVM CLI commands to create and maintain logical volumes.
- [Chapter 5, LVM Configuration Examples](#) provides a variety of LVM configuration examples.
- [Chapter 6, LVM Troubleshooting](#) provide instructions for troubleshooting a variety of LVM issues.
- [Chapter 7, LVM Administration with the LVM GUI](#) summarizes the operating of the LVM GUI.
- [Appendix A, The Device Mapper](#) describes the Device Mapper that LVM uses to map logical and physical volumes.
- [Appendix B, The LVM Configuration Files](#) describes the LVM configuration files.
- [Appendix C, LVM Object Tags](#) describes LVM object tags and host tags.
- [Appendix D, LVM Volume Group Metadata](#) describes LVM volume group metadata, and includes a sample copy of metadata for an LVM volume group.

LVM Components

This chapter describes the components of an LVM Logical volume.

1. Physical Volumes

The underlying physical storage unit of an LVM logical volume is a block device such as a partition or whole disk. To use the device for an LVM logical volume the device must be initialized as a physical volume (PV). Initializing a block device as a physical volume places a label near the start of the device.

By default, the LVM label is placed in the second 512-byte sector. You can overwrite this default by placing the label on any of the first 4 sectors. This allows LVM volumes to co-exist with other users of these sectors, if necessary.

An LVM label provides correct identification and device ordering for a physical device, since devices can come up in any order when the system is booted. An LVM label remains persistent across reboots and throughout a cluster.

The LVM label identifies the device as an LVM physical volume. It contains a random unique identifier (the UUID) for the physical volume. It also stores the size of the block device in bytes, and it records where the LVM metadata will be stored on the device.

The LVM metadata contains the configuration details of the LVM volume groups on your system. By default, an identical copy of the metadata is maintained in every metadata area in every physical volume within the volume group. LVM metadata is small and stored as ASCII.

Currently LVM allows you to store 0, 1 or 2 identical copies of its metadata on each physical volume. The default is 1 copy. Once you configure the number of metadata copies on the physical volume, you cannot change that number at a later time. The first copy is stored at the start of the device, shortly after the label. If there is a second copy, it is placed at the end of the device. If you accidentally overwrite the area at the beginning of your disk by writing to a different disk than you intend, a second copy of the metadata at the end of the device will allow you to recover the metadata.

For detailed information about the LVM metadata and changing the metadata parameters, see [Appendix D, LVM Volume Group Metadata](#).

1.1. LVM Physical Volume Layout

Figure 2.1, “Physical Volume layout” shows the layout of an LVM physical volume. The LVM label is on the second sector, followed by the metadata area, followed by the usable space on the device.



Note

In the Linux kernel (and throughout this document), sectors are considered to be 512 bytes in size.

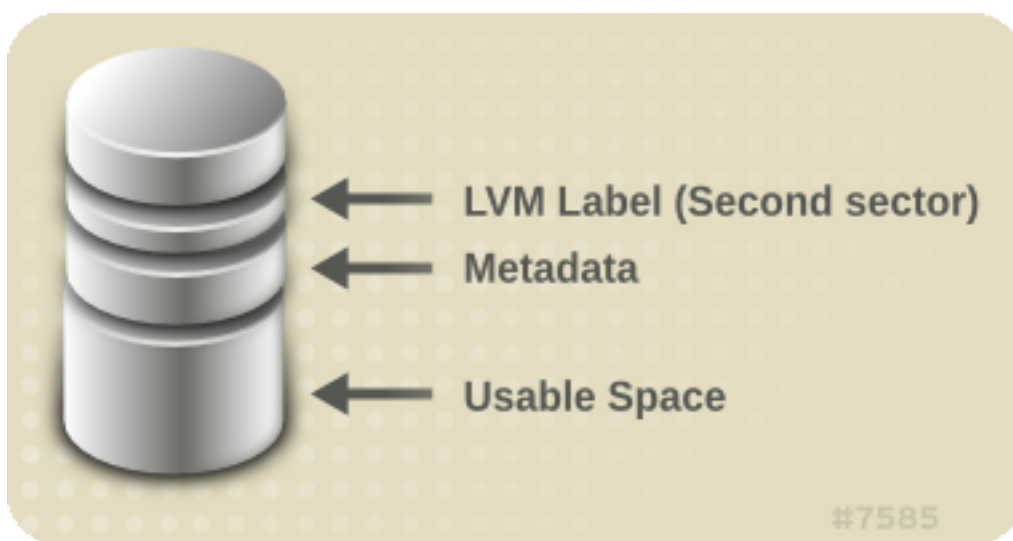

Figure 2.1. Physical Volume layout

1.2. Multiple Partitions on a Disk

LVM allows you to create physical volumes out of disk partitions. It is generally recommended that you create a single partition that covers the whole disk to label as an LVM physical volume for the following reasons:

- Administrative convenience

It is easier to keep track of the hardware in a system if each real disk only appears once. This becomes particularly true if a disk fails. In addition, multiple physical volumes on a single disk may cause a kernel warning about unknown partition types at boot-up.

- Striping performance

LVM can not tell that two physical volumes are on the same physical disk. If you create a striped logical volume when two physical volumes are on the same physical disk, the stripes could be on different partitions on the same disk. This would result in a decrease in performance rather than an increase.

Although it is not recommended, there may be specific circumstances when you will need to divide a disk into separate LVM physical volumes. For example, on a system with few disks it may be necessary to move data around partitions when you are migrating an existing system to LVM volumes. Additionally, if you have a very large disk and want to have more than one volume group for administrative purposes then it is necessary to partition the disk. If you do have a disk with more than one partition and both of those partitions are in the same volume group, take care to specify which partitions are to be included in a logical volume when creating striped volumes.

2. Volume Groups

Physical volumes are combined into volume groups (VGs). This creates a pool of disk space out of which logical volumes can be allocated.

Within a volume group, the disk space available for allocation is divided into units of a fixed-size called extents. An extent is the smallest unit of space that can be allocated. Within a physical volume, extents are referred to as physical extents.

A logical volume is allocated into logical extents of the same size as the physical extents. The extent size is thus the same for all logical volumes in the volume group. The volume group maps the logical extents to physical extents.

3. LVM Logical Volumes

In LVM, a volume group is divided up into logical volumes. There are three types of LVM logical volumes: linear volumes, striped volumes, and mirrored volumes. These are described in the following sections.

3.1. Linear Volumes

A linear volume aggregates multiple physical volumes into one logical volume. For example, if you have two 60GB disks, you can create a 120GB logical volume. The physical storage is concatenated.

Creating a linear volume assigns a range of physical extents to an area of a logical volume in order. For example, as shown in [Figure 2.2, “Extent Mapping”](#) logical extents 1 to 99 could map to one physical volume and logical extents 100 to 198 could map to a second physical volume. From the point of view of the application, there is one device that is 198 extents in size.

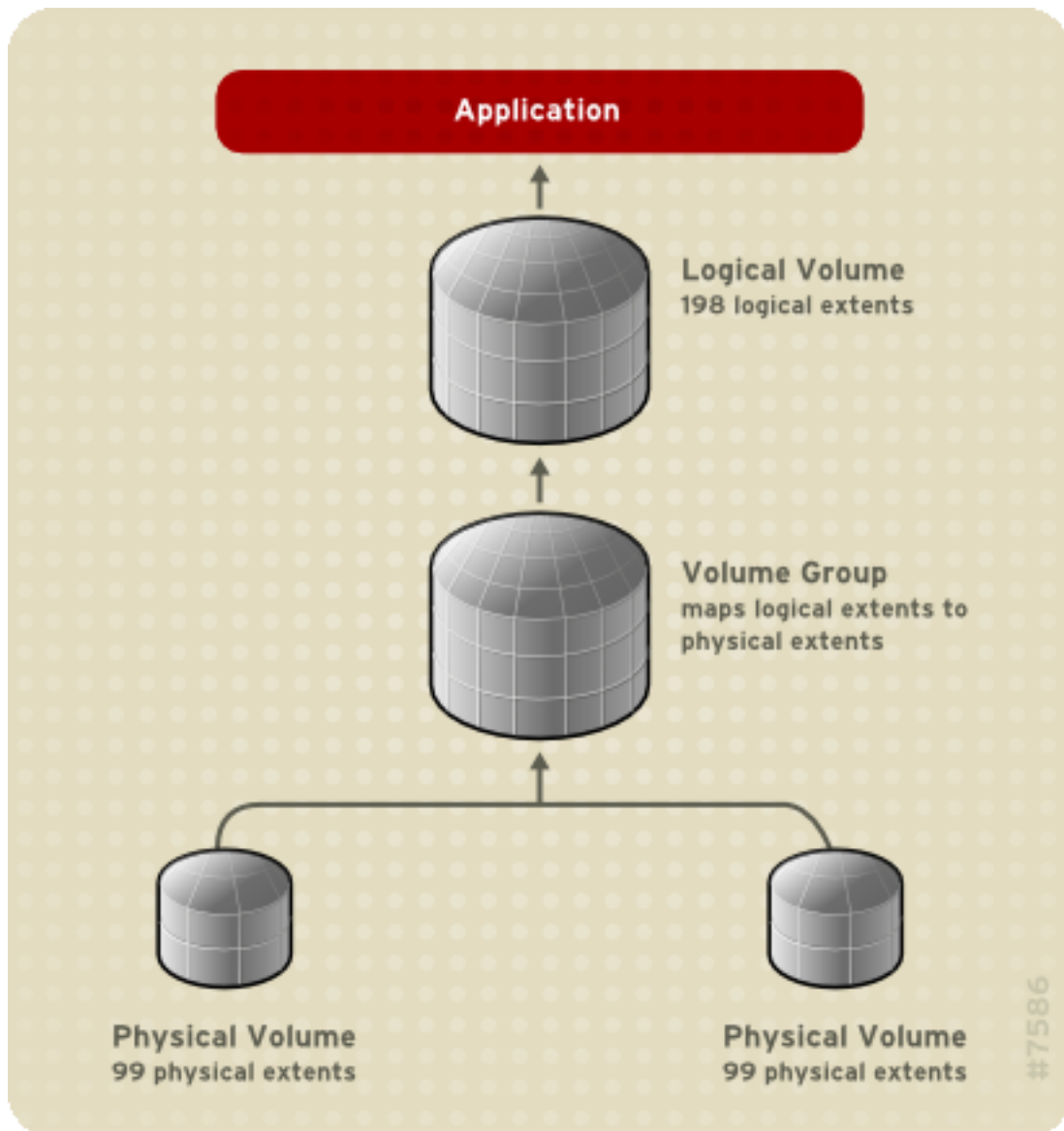

Figure 2.2. Extent Mapping

The physical volumes that make up a logical volume do not have to be the same size. [Figure 2.3, “Linear Volume with Unequal Physical Volumes”](#) shows volume group VG1 with a physical extent size of 4MB. This volume group includes 2 physical volumes named PV1 and PV2. The physical volumes are divided into 4MB units, since

that is the extent size. In this example, PV1 is 100 extents in size (400MB) and PV2 is 200 extents in size (800MB). You can create a linear volume any size between 1 and 300 extents (4MB to 1200MB). In this example, the linear volume named LV1 is 300 extents in size.

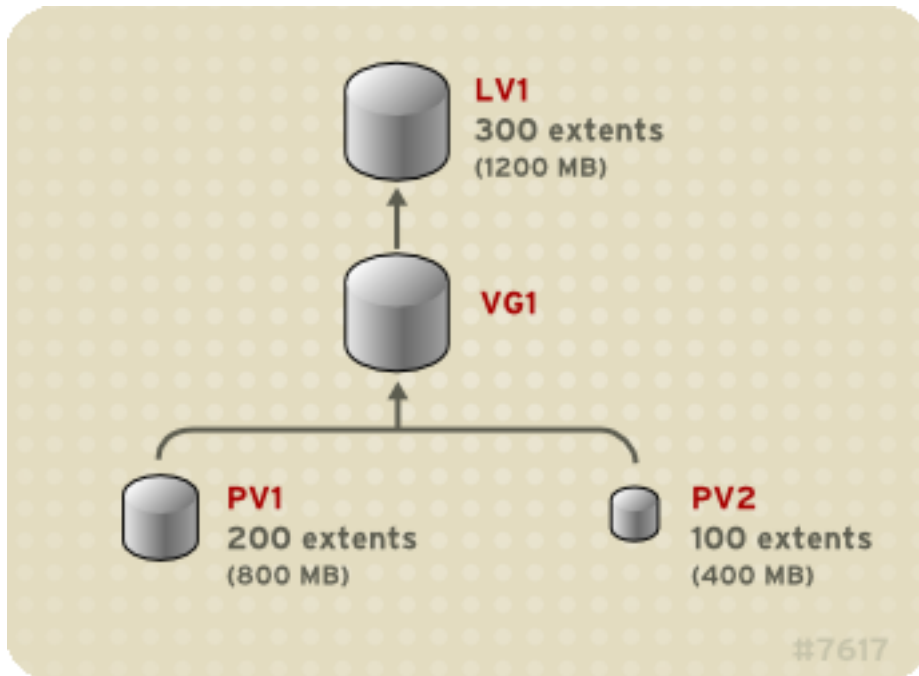

Figure 2.3. Linear Volume with Unequal Physical Volumes

You can configure more than one linear logical volume of whatever size you desire from the pool of physical extents. [Figure 2.4, “Multiple Logical Volumes”](#) shows the same volume group as in [Figure 2.3, “Linear Volume with Unequal Physical Volumes”](#), but in this case two logical volumes have been carved out of the volume group: LV1, which is 250 extents in size (1000MB) and LV2 which is 50 extents in size (200MB).

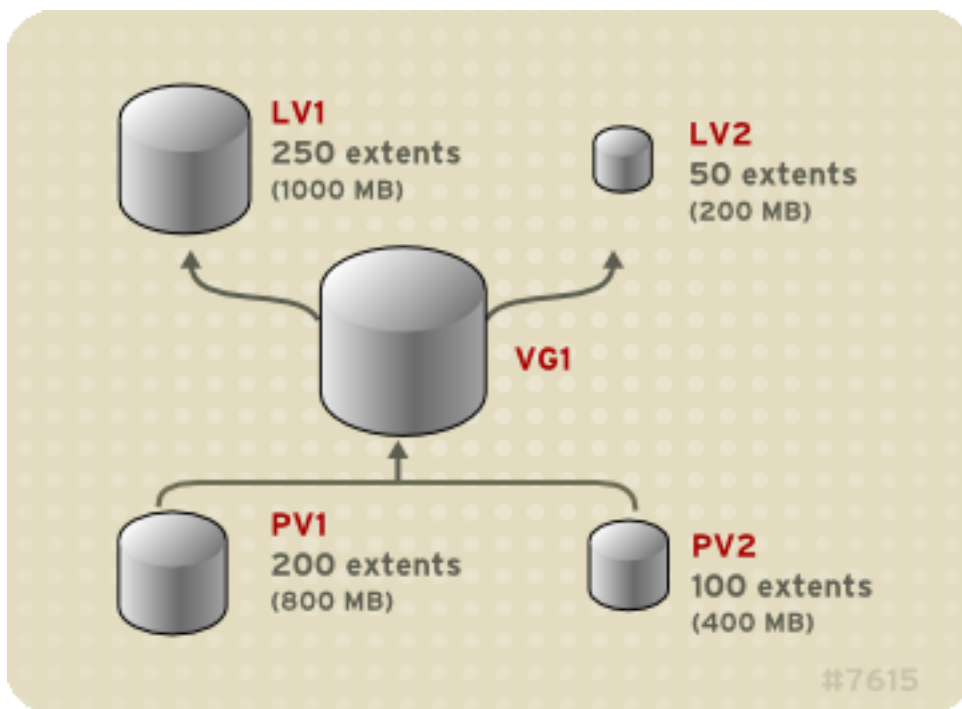

Figure 2.4. Multiple Logical Volumes

3.2. Striped Logical Volumes

When you write data to an LVM logical volume, the file system lays the data out across the underlying physical volumes. You can control the way the data is written to the physical volumes by creating a striped logical volume. For large sequential reads and writes, this can improve the efficiency of the data I/O.

Striping enhances performance by writing data to a predetermined number of physical volumes in round-round fashion. With striping, I/O can be done in parallel. In some situations, this can result in near-linear performance gain for each additional physical volume in the stripe.

The following illustration shows data being striped across three physical volumes. In this figure:

- the first stripe of data is written to PV1
- the second stripe of data is written to PV2
- the third stripe of data is written to PV3

- the fourth stripe of data is written to PV1

In a striped logical volume, the size of the stripe cannot exceed the size of an extent.

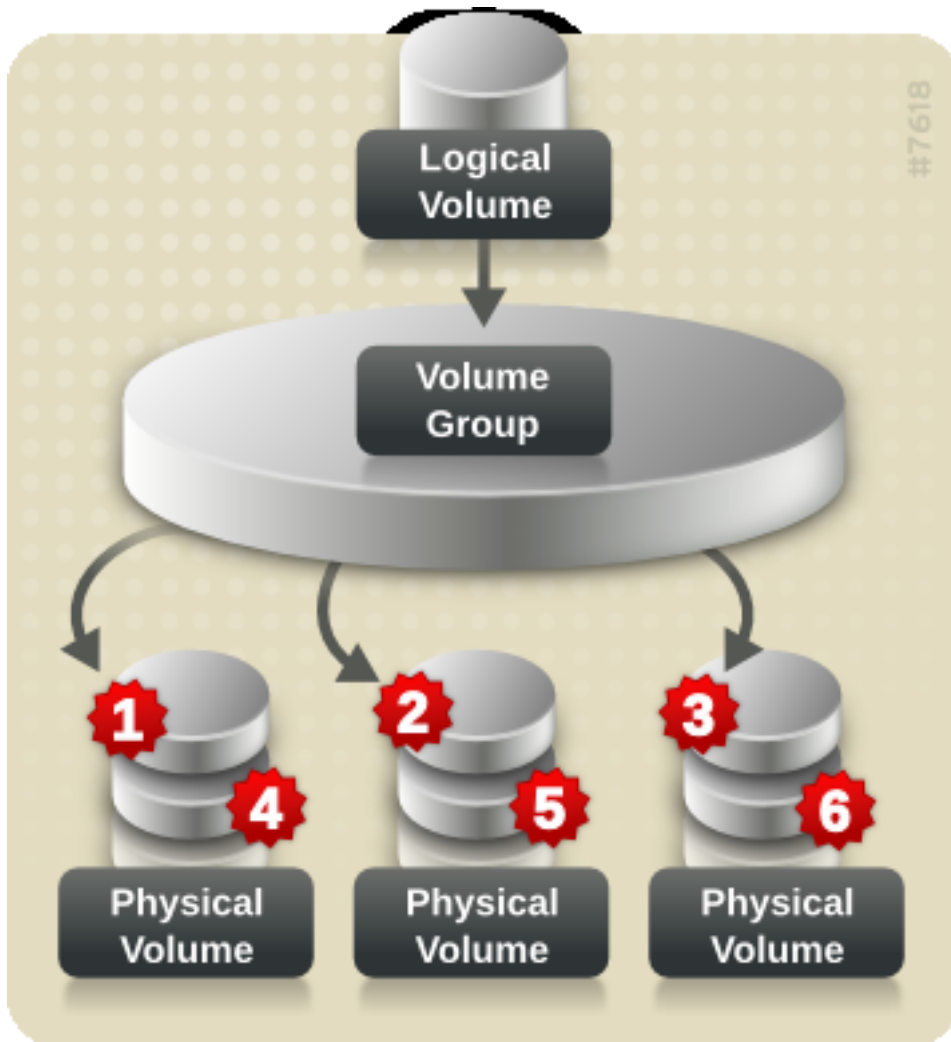

Figure 2.5. Striping Data Across Three PVs

Striped logical volumes can be extended by concatenating another set of devices onto the end of the first set. In order to extend a striped logical volume, however, there must be enough free space on the underlying physical volumes that make up the volume group to support the stripe. For example, if you have a two-way stripe that uses up an entire volume group, adding a single physical volume to the volume group will not enable you to extend the stripe. Instead, you must add at least two physical volumes to the volume group. For more information on extending a striped volume, see [Section 4.9, “Extending a Striped Volume”](#).

3.3. Mirrored Logical Volumes

A mirror maintains identical copies of data on different devices. When data is written to one device, it is written to a second device as well, mirroring the data. This provides protection for device failures. When one leg of a mirror fails, the logical volume becomes a linear volume and can still be accessed.

LVM supports mirrored volumes. When you create a mirrored logical volume, LVM ensures that data written to an underlying physical volume is mirrored onto a separate physical volume. With LVM, you can create mirrored logical volumes with multiple mirrors.

An LVM mirror divides the device being copied into regions that are typically 512KB in size. LVM maintains a small log which it uses to keep track of which regions are in sync with the mirror or mirrors. This log can be kept on disk, which will keep it persistent across reboots, or it can be maintained in memory.

Figure 2.6, “Mirrored Logical Volume” shows a mirrored logical volume with one mirror. In this configuration, the log is maintained on disk.

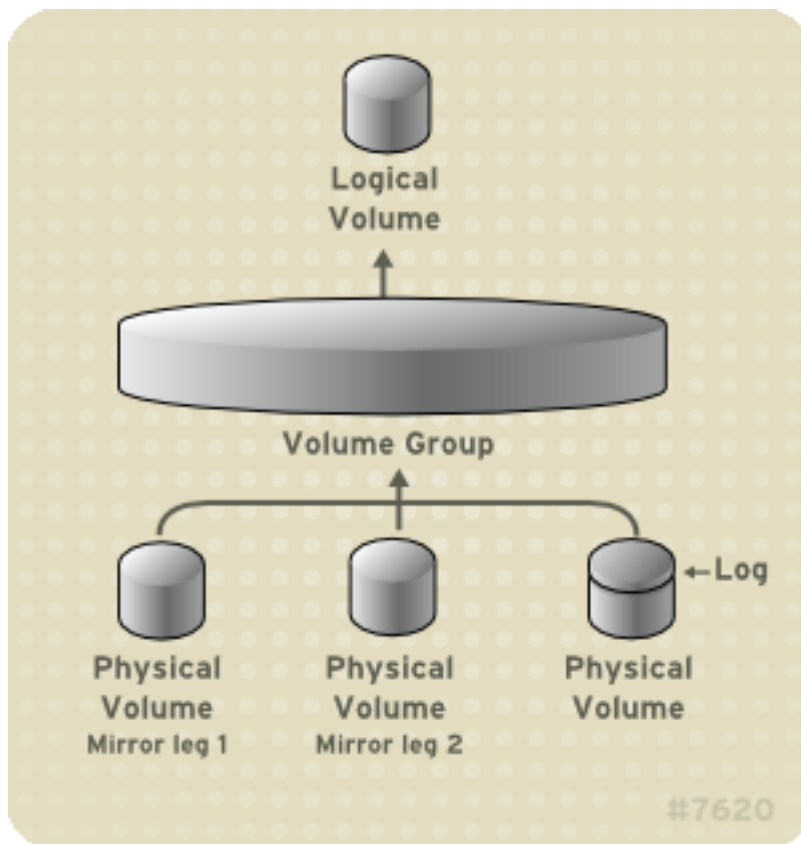

Figure 2.6. Mirrored Logical Volume

**Note**

Mirrored logical volumes are not currently supported in a cluster.

For information on creating and modifying mirrors, see [Section 4.1.3, “Creating Mirrored Volumes”](#).

3.4. Snapshot Volumes

The LVM snapshot feature provides the ability to create virtual images of a device at a particular instant without causing a service interruption. When a change is made to the original device (the origin) after a snapshot is taken, the snapshot feature makes a copy of the changed data area as it was prior to the change so that it can reconstruct the state of the device.

**Note**

LVM snapshots are not supported across the nodes in a cluster.

Because a snapshot copies only the data areas that change after the snapshot is created, the snapshot feature requires a minimal amount of storage. For example, with a rarely updated origin, 3-5 % of the origin's capacity is sufficient to maintain the snapshot.

**Note**

Snapshot copies of a file system are virtual copies, not actual media backup for a file system. Snapshots do not provide a substitute for a backup procedure.

If a snapshot runs full, the snapshot is dropped. This is to be sure that there is enough space for the origin file system. You should regularly monitor the size of the snapshot. Snapshots are fully resizeable, however, so if you have the storage capacity you can increase the size of the snapshot volume to prevent it from getting dropped. Conversely, if you find that the snapshot volume is larger than you need, you can reduce the size of the volume to free up space that is needed by other

logical volumes.

When you create a snapshot file system, full read and write access to the origin stays possible. If a chunk on a snapshot is changed, that chunk is marked and never gets copied from the original volume.

There are several uses for the snapshot feature:

- Most typically, a snapshot is taken when you need to perform a backup on a logical volume without halting the live system that is continuously updating the data.
- You can execute the `fsck` command on a snapshot file system to check the file system integrity and determine whether the original file system requires file system repair.
- Because the snapshot is read/write, you can test applications against production data by taking a snapshot and running tests against the snapshot, leaving the real data untouched.
- You can create volumes for use with the Xen virtual machine monitor. You can use the snapshot feature to create a disk image, snapshot it, and modify the snapshot for a particular domU instance. You can then create another snapshot and modify it for another domU instance. Since the only storage used is chunks that were changed on the origin or snapshot, the majority of the volume is shared.

LVM Administration Overview

This chapter provides an overview of the administrative procedures you use to configure LVM logical volumes. This chapter is intended to provide a general understanding of the steps involved. For specific step-by-step examples of common LVM configuration procedures, see [Chapter 5, LVM Configuration Examples](#).

For descriptions of the CLI commands you can use to perform LVM administration, see [Chapter 4, LVM Administration with CLI Commands](#). Alternately, you can use the LVM GUI, which is described in [Chapter 7, LVM Administration with the LVM GUI](#).

1. Creating LVM Volumes in a Cluster

Creating LVM logical volumes in a cluster environment is identical to creating LVM logical volumes on a single node. There is no difference in the LVM commands themselves, or in the LVM GUI interface. In order to enable the LVM volumes you are creating in a cluster, the cluster infrastructure must be running and the cluster must be quorate.

For information on how to set up the cluster infrastructure, see [Configuring and Managing a Red Hat Cluster](#).

2. Logical Volume Creation Overview

The following is a summary of the steps to perform to create an LVM logical volume.

1. Initialize the partitions you will use for the LVM volume as physical volumes (this labels them).
2. Create a volume group.
3. Create a logical volume.

After creating the logical volume you can create and mount the file system. The examples in this document use GFS file systems.

1. Create a GFS file system on the logical volume with the `gfs_mkfs` command.
2. Create a new mount point with the `mkdir` command. In a clustered system, create the mount point on all nodes in the cluster.

3. Mount the file system. You may want to add a line to the `fstab` file for each node in the system.

Alternately, you can create and mount the GFS file system with the LVM GUI.

Creating the LVM volume is machine independent, since the storage area for LVM setup information is on the physical volumes and not the machine where the volume was created. Servers that use the storage have local copies, but can recreate that from what is on the physical volumes. You can attach physical volumes to a different server if the LVM versions are compatible.

3. Growing a File System on a Logical Volume

To grow a file system on a logical volume, perform the following steps:

1. Make a new physical volume.
2. Extend the volume group that contains the logical volume with the file system you are growing to include the new physical volume.
3. Extend the logical volume to include the new physical volume.
4. Grow the file system.

If you have sufficient unallocated space in the volume group, you can use that space to extend the logical volume instead of performing steps 1 and 2.

4. Logical Volume Backup

Metadata backups and archives are automatically created on every volume group and logical volume configuration change unless disabled in the `lvm.conf` file. By default, the metadata backup is stored in the `/etc/lvm/backup` file and the metadata archives are stored in the `/etc/lvm/archive` file. How long the the metadata archives stored in the `/etc/lvm/archive` file are kept and how many archive files are kept is determined by parameters you can set in the `lvm.conf` file. A daily system backup should include the contents of the `/etc/lvm` directory in the backup.

Note that a metadata backup does not back up the user and system data contained in the logical volumes.

You can manually back up the metadata to the `/etc/lvm/backup` file with the `vgcfgbackup` command. You can restore metadata with the `vgcfgrestore` command.

The `vgcfgbackup` and `vgcfgrestore` commands are described in [Section 3.11, “Backing Up Volume Group Metadata”](#).

5. Logging

All message output passes through a logging module with independent choices of logging levels for:

- standard output/error
- syslog
- log file
- external log function

The logging levels are set in the `/etc/lvm/lvm.conf` file, which is described in [Appendix B, The LVM Configuration Files](#).

LVM Administration with CLI

Commands

This chapter summarizes the individual administrative tasks you can perform with the LVM Command Line Interface (CLI) commands to create and maintain logical volumes.

1. Using CLI Commands

There are several general features of all LVM CLI commands.

When sizes are required in a command line argument, units can always be specified explicitly. If you do not specify a unit, then a default is assumed, usually KB or MB. LVM CLI commands do not accept fractions.

When specifying units in a command line argument, LVM is case-insensitive; specifying M or m is equivalent, for example, and powers of 2 (multiples of 1024) are used. However, when specifying the --units argument in a command, lower-case indicates that units are in multiples of 1024 while upper-case indicates that units are in multiples of 1000.

Where commands take volume group or logical volume names as arguments, the full path name is optional. A logical volume called `lv0` in a volume group called `vg0` can be specified as `vg0/lv0`. Where a list of volume groups is required but is left empty, a list of all volume groups will be substituted. Where a list of logical volumes is required but a volume group is given, a list of all the logical volumes in that volume group will be substituted. For example, the `lvdisplay vg0` command will display all the logical volumes in volume group `vg0`.

All LVM commands accept a `-v` argument, which can be entered multiple times to increase the output verbosity. For example, the following examples shows the default output of the `lvcreate` command.

```
# lvcreate -L 50MB new_vg
Rounding up size to full physical extent 52.00 MB
Logical volume "lv0" created
```

The following command shows the output of the `lvcreate` command with the `-v`

argument.

```
# lvcreate -v -L 50MB new_vg
  Finding volume group "new_vg"
  Rounding up size to full physical extent 52.00 MB
  Archiving volume group "new_vg" metadata (seqno 4).
  Creating logical volume lvol0
  Creating volume group backup "/etc/lvm/backup/new_vg" (seqno 5).
  Found volume group "new_vg"
  Creating new_vg-lvol0
  Loading new_vg-lvol0 table
  Resuming new_vg-lvol0 (253:2)
  Clearing start of logical volume "lvol0"
  Creating volume group backup "/etc/lvm/backup/new_vg" (seqno 5).
  Logical volume "lvol0" created
```

You could also have used the `-vv`, `-vvv` or the `-vvvv` argument to display increasingly more details about the command execution. The `-vvvv` argument provides the maximum amount of information at this time. The following example shows only the first few lines of output for the `lvcreate` command with the `-vvvv` argument specified.

```
# lvcreate -vvvv -L 50MB new_vg
#lvmcmdline.c:913      Processing: lvcreate -vvvv -L 50MB new_vg
#lvmcmdline.c:916      O_DIRECT will be used
#config/config.c:864  Setting global/locking_type to 1
#locking/locking.c:138  File-based locking selected.
#config/config.c:841  Setting global/locking_dir to /var/lock/lvm
#activate/activate.c:358  Getting target version for linear
#ioctl/libdm-iface.c:1569  dm version  OF [16384]
#ioctl/libdm-iface.c:1569  dm versions  OF [16384]
#activate/activate.c:358  Getting target version for striped
#ioctl/libdm-iface.c:1569  dm versions  OF [16384]
#config/config.c:864  Setting activation/mirror_region_size to 512
...
```

You can display help for any of the LVM CLI commands with the `--help` argument of the command.

```
commandname --help
```

To display the man page for a command, execute the man command:

```
man commandname
```

The man lvm command provides general online information about LVM.

All LVM objects are referenced internally by a UUID, which is assigned when you create the object. This can be useful in a situation where you remove a physical volume called /dev/sdf which is part of a volume group and, when you plug it back in, you find that it is now /dev/sdk. LVM will still find the physical volume because it identifies the physical volume by its UUID and not its device name. For information on specifying the UUID of a physical volume when creating a physical volume, see see [Section 4, “Recovering Physical Volume Metadata”](#).

2. Physical Volume Administration

This section describes the commands that perform the various aspects of physical volume administration.

2.1. Creating Physical Volumes

The following subsections describe the commands used for creating physical volumes.

2.1.1. Setting the Partition Type

If you are using a whole disk device for your physical volume, the disk must have no partition table. For DOS disk partitions, the partition id should be set to 0x8e using the fdisk or cfdisk command or an equivalent. For whole disk devices only the partition table must be erased, which will effectively destroy all data on that disk. You can remove an existing partition table by zeroing the first sector with the following command:

```
dd if=/dev/zero of=PhysicalVolume bs=512 count=1
```

2.1.2. Initializing Physical Volumes

Use the pvcreate command to initialize a block device to be used as a physical volume. Initialization is analogous to formatting a file system.

The following command initializes /dev/sdd1, /dev/sde1, and /dev/sdf1 for use as LVM physical volumes.

```
pvcreate /dev/sdd1 /dev/sde1 /dev/sdf1
```

To initialize partitions rather than whole disks: run the pvcreate command on the partition. The following example initializes /dev/hdb1 as an LVM physical volume for later use as part of an LVM logical volume.

```
pvcreate /dev/hdb1
```

2.1.3. Scanning for Block Devices

You can scan for block devices that may be used as physical volumes with the `lvmdiskscan` command, as shown in the following example.

```
# lvmdiskscan
/dev/ram0          [ 16.00 MB]
/dev/sda          [ 17.15 GB]
/dev/root         [ 13.69 GB]
/dev/ram          [ 16.00 MB]
/dev/sda1         [ 17.14 GB] LVM physical volume
/dev/VolGroup00/LogVol01 [ 512.00 MB]
/dev/ram2         [ 16.00 MB]
/dev/new_vg/lvol0 [ 52.00 MB]
/dev/ram3         [ 16.00 MB]
/dev/pkl_new_vg/sparkie_lv [ 7.14 GB]
/dev/ram4         [ 16.00 MB]
/dev/ram5         [ 16.00 MB]
/dev/ram6         [ 16.00 MB]
/dev/ram7         [ 16.00 MB]
/dev/ram8         [ 16.00 MB]
/dev/ram9         [ 16.00 MB]
/dev/ram10        [ 16.00 MB]
/dev/ram11        [ 16.00 MB]
/dev/ram12        [ 16.00 MB]
/dev/ram13        [ 16.00 MB]
/dev/ram14        [ 16.00 MB]
/dev/ram15        [ 16.00 MB]
```

```
/dev/sdb          [ 17.15 GB]
/dev/sdb1        [ 17.14 GB] LVM physical volume
/dev/sdc          [ 17.15 GB]
/dev/sdc1        [ 17.14 GB] LVM physical volume
/dev/sdd          [ 17.15 GB]
/dev/sdd1        [ 17.14 GB] LVM physical volume
7 disks
17 partitions
0 LVM physical volume whole disks
4 LVM physical volumes
```

2.2. Displaying Physical Volumes

There are three commands you can use to display properties of LVM physical volumes: `pvs`, `pvdisplay`, and `pvscan`.

The `pvs` command provides physical volume information in a configurable form, displaying one line per physical volume. The `pvs` command provides a great deal of format control, and is useful for scripting. For information on using the `pvs` command to customize your output, see [Section 9, “Customized Reporting for LVM”](#).

The `pvdisplay` command provides a verbose multi-line output for each physical volume. It displays physical properties (size, extents, volume group, etc.) in a fixed format.

The following example shows the output of the `pvdisplay` command for a single physical volume.

```
# pvdisplay
--- Physical volume ---
PV Name          /dev/sdc1
VG Name          new_vg
PV Size          17.14 GB / not usable 3.40 MB
Allocatable      yes
PE Size (KByte)  4096
Total PE         4388
Free PE          4375
Allocated PE     13
PV UUID          Joqlch-yWSj-kuEn-ldwM-01S9-XO8M-mcpsVe
```

The `pvscan` command scans all supported LVM block devices in the system for

physical volumes.

The following command shows all physical devices found:

```
# pvscan
PV /dev/sdb2 VG vg0 lvm2 [964.00 MB / 0 free]
PV /dev/sdc1 VG vg0 lvm2 [964.00 MB / 428.00 MB free]
PV /dev/sdc2 lvm2 [964.84 MB]
Total: 3 [2.83 GB] / in use: 2 [1.88 GB] / in no VG: 1 [964.84 MB]
```

You can define a filter in the `lvm.conf` so that this command will avoid scanning specific physical volumes. For information on using filters to control which devices are scanned, see [Section 6, “Controlling LVM Device Scans with Filters”](#).

2.3. Preventing Allocation on a Physical Volume

You can prevent allocation of physical extents on the free space of one or more physical volumes with the `pvchange` command. This may be necessary if there are disk errors, or if you will be removing the physical volume.

The following command disallows the allocation of physical extents on `/dev/sdk1`.

```
pvchange -x n /dev/sdk1
```

You can also use the `-xy` arguments of the `pvchange` command to allow allocation where it had previously been disallowed.

2.4. Resizing a Physical Volume

If you need to change the size of an underlying block device for any reason, use the `pvresize` command to update LVM with the new size. You can execute this command while LVM is using the physical volume.

2.5. Removing Physical Volumes

If a device is no longer required for use by LVM, you can remove the LVM label with the `pvremove` command. Executing the `pvremove` command zeroes the LVM metadata on an empty physical volume.

If the physical volume you want to remove is currently part of a volume group, you

must remove it from the volume group with the `vgreduce` command, as described in [Section 3.5, “Removing Physical Volumes from a Volume Group”](#).

```
# pvremove /dev/ram15  
Labels on physical volume "/dev/ram15" successfully wiped
```

3. Volume Group Administration

This section describes the commands that perform the various aspects of volume group administration.

3.1. Creating Volume Groups

To create a volume group from one or more physical volumes, use the `vgcreate` command. The `vgcreate` command creates a new volume group by name and adds at least one physical volume to it.

The following command creates a volume group named `vg1` that contains physical volumes `/dev/sdd1` and `/dev/sde1`.

```
vgcreate vg1 /dev/sdd1 /dev/sde1
```

When physical volumes are used to create a volume group, its disk space is divided into 4MB extents, by default. This extent is the minimum amount by which the logical volume may be increased or decreased in size. Large numbers of extents will have no impact on I/O performance of the logical volume.

You can specify the extent size with the `vgcreate` command if the default is not suitable with the `-s` argument. You can put limits on the number of physical or logical volumes the volume group can have by using the `-p` and `-l` arguments of the `vgcreate` command.

By default, a volume group allocates physical extents according to common-sense rules such as not placing parallel stripes on the same physical volume. This is the normal allocation policy. You can use the `--alloc` argument of the `vgcreate` command to specify an allocation policy of contiguous, anywhere, or cling.

The contiguous policy requires that new extents are adjacent to existing extents. If there are sufficient free extents to satisfy an allocation request but a normal

allocation policy would not use them, the anywhere allocation policy will, even if that reduces performance by placing two stripes on the same physical volume. The cling policy places new extents on the same physical volume as existing extents in the same stripe of the logical volume. These policies can be changed using the `vgchange` command.

In general, allocation policies other than normal are required only in special cases where you need to specify unusual or nonstandard extent allocation.

LVM volume groups and underlying logical volumes are included in the device special file directory tree in the `/dev` directory with the following layout:

```
/dev/vg/lv/
```

For example, if you create two volume groups `myvg1` and `myvg2`, each with three logical volumes named `lv01`, `lv02`, and `lv03`, this create six device special files:

```
/dev/myvg1/lv01  
/dev/myvg1/lv02  
/dev/myvg1/lv03  
/dev/myvg2/lv01  
/dev/myvg2/lv02  
/dev/myvg2/lv03
```

The maximum device size with LVM is 8 Exabytes on 64-bit CPUs.

3.2. Adding Physical Volumes to a Volume Group

To add additional physical volumes to an existing volume group, use the `vgextend` command. The `vgextend` command increases a volume group's capacity by adding one or more free physical volumes.

The following command adds the physical volume `/dev/sdf1` to the volume group `vg1`.

```
vgextend vg1 /dev/sdf1
```

3.3. Displaying Volume Groups

There are two commands you can use to display properties of LVM volume groups: `vgs` and `vgdisplay`.

The `vgscan` command will also display the volume groups, although its primary purpose is to scan all the disks for volume groups and rebuild the LVM cache file. For information on the `vgscan` command, see [Section 3.4, “Scanning Disks for Volume Groups to Build the Cache File”](#).

The `vgs` command provides volume group information in a configurable form, displaying one line per volume group. The `vgs` command provides a great deal of format control, and is useful for scripting. For information on using the `vgs` command to customize your output, see [Section 9, “Customized Reporting for LVM”](#).

The `vgdisplay` command displays volume group properties (such as size, extents, number of physical volumes, etc.) in a fixed form. The following example shows the output of a `vgdisplay` command for the volume group `new_vg`. If you do not specify a volume group, all existing volume groups are displayed.

```
# vgdisplay new_vg
--- Volume group ---
VG Name          new_vg
System ID
Format          lvm2
Metadata Areas   3
Metadata Sequence No 11
VG Access        read/write
VG Status        resizable
MAX LV          0
Cur LV          1
Open LV          0
Max PV           0
Cur PV          3
Act PV           3
VG Size          51.42 GB
PE Size          4.00 MB
Total PE         13164
Alloc PE / Size  13 / 52.00 MB
Free PE / Size   13151 / 51.37 GB
VG UUID          jxQJ0a-ZKk0-OpMO-0118-nlwO-wwqd-fD5D32
```

3.4. Scanning Disks for Volume Groups to Build the

Cache File

The `vgscan` command scans all supported disk devices in the system looking for LVM physical volumes and volume groups. This builds the LVM cache in the `/etc/lvm/.cache` file, which maintains a listing of current LVM devices.

LVM runs the `vgscan` command automatically at system startup and at other times during LVM operation, such as when you execute a `vgcreate` command or when LVM detects an inconsistency. You may need to run the `vgscan` command manually when you change your hardware configuration, causing new devices to be visible to the system that were not present at system bootup. This may be necessary, for example, when you add new disks to the system on a SAN or hotplug a new disk that has been labeled as a physical volume.

You can define a filter in the `lvm.conf` file to restrict the scan to avoid specific devices. For information on using filters to control which devices are scanned, see [Section 6, “Controlling LVM Device Scans with Filters”](#).

The following example shows the output of a `vgscan` command.

```
# vgscan
Reading all physical volumes. This may take a while...
Found volume group "new_vg" using metadata type lvm2
Found volume group "officevg" using metadata type lvm2
```

3.5. Removing Physical Volumes from a Volume Group

To remove unused physical volumes from a volume group, use the `vgreduce` command. The `vgreduce` command shrinks a volume group's capacity by removing one or more empty physical volumes. This frees those physical volumes to be used in different volume groups or to be removed from the system.

Before removing a physical volume from a volume group, you can make sure that the physical volume is not used by any logical volumes by using the `pvdisplay` command.

```
# pvdisplay /dev/hda1

-- Physical volume ---
```

```
PV Name      /dev/hda1
VG Name      myvg
PV Size      1.95 GB / NOT usable 4 MB [LVM: 122 KB]
PV#          1
PV Status    available
Allocatable  yes (but full)
Cur LV      1
PE Size (KByte) 4096
Total PE     499
Free PE      0
Allocated PE 499
PV UUID      Sd44tK-9IRw-SrMC-MOkn-76iP-iftz-OVSen7
```

If the physical volume is still being used you will have to migrate the data to another physical volume using the `pvmove` command. Then use the `vgreduce` command to remove the physical volume:

The following command removes the physical volume `/dev/hda1` from the volume group `my_volume_group`.

```
# vgreduce my_volume_group /dev/hda1
```

3.6. Changing the Parameters of a Volume Group

There are several volume group parameters that you can change for an existing volume group with the `vgchange` command. Primarily, however, this command is used to deactivate and activate volume groups, as described in [Section 3.7, “Activating and Deactivating Volume Groups”](#),

The following command changes the maximum number of logical volumes of volume group `vg00` to 128.

```
vgchange -l 128 /dev/vg00
```

For a description of the volume group parameters you can change with the `vgchange` command, see the `vgchange(8)` man page.

3.7. Activating and Deactivating Volume Groups

When you create a volume group it is, by default, activated. This means that the logical volumes in that group are accessible and subject to change.

There are various circumstances for which you need to make a volume group inactive and thus unknown to the kernel. To deactivate or activate a volume group, use the `-a` (`--available`) argument of the `vgchange` command.

The following example deactivates the volume group `my_volume_group`.

```
vgchange -a n my_volume_group
```

If clustered locking is enabled, add `'e'` to activate or deactivate a volume group exclusively on one node or `'l'` to activate or deactivate a volume group only on the local node. Logical volumes with single-host snapshots are always activated exclusively because they can only be used on one node at once.

You can deactivate individual logical volumes with the `lvchange` command, as described in [Section 4.4, “Changing the Parameters of a Logical Volume Group”](#). For information on activating logical volumes on individual nodes in a cluster, see [Section 8, “Activating Logical Volumes on Individual Nodes in a Cluster”](#).

3.8. Removing Volume Groups

To remove a volume group that contains no logical volumes, use the `vgremove` command.

```
# vgremove officevg  
Volume group "officevg" successfully removed
```

3.9. Splitting a Volume Group

To split the physical volumes of a volume group and create a new volume group, use the `vgsplit` command.

Logical volumes cannot be split between volume groups. Each existing logical volume must be entirely on the physical volumes forming either the old or the new volume group. If necessary, however, you can use the `pvmove` command to force the split.

The following example splits off the new volume group `smallvg` from the original volume group `bigvg`.

```
# vgsplit bigvg smallvg /dev/ram15
Volume group "smallvg" successfully split from "bigvg"
```

3.10. Combining Volume Groups

To combine two volume groups into a single volume group, use the `vgmerge` command. You can merge an inactive "source" volume with an active or an inactive "destination" volume if the physical extent sizes of the volume are equal and the physical and logical volume summaries of both volume groups fit into the destination volume groups limits.

The following command merges the inactive volume group `my_vg` into the active or inactive volume group `databases` giving verbose runtime information.

```
vgmerge -v databases my_vg
```

3.11. Backing Up Volume Group Metadata

Metadata backups and archives are automatically created on every volume group and logical volume configuration change unless disabled in the `lvm.conf` file. By default, the metadata backup is stored in the `/etc/lvm/backup` file and the metadata archives are stored in the `/etc/lvm/archives` file. You can manually back up the metadata to the `/etc/lvm/backup` file with the `vgcfgbackup` command.

The `vgcfgrestore` command restores the metadata of a volume group from the archive to all the physical volumes in the volume groups.

For an example of using the `vgcfgrestore` command to recover physical volume metadata, see [Section 4, "Recovering Physical Volume Metadata"](#).

3.12. Renaming a Volume Group

Use the `vgrename` command to rename an existing volume group.

Either of the following commands renames the existing volume group `vg02` to `my_volume_group`

```
vgrename /dev/vg02 /dev/my_volume_group
```

```
vgrename vg02 my_volume_group
```

3.13. Moving a Volume Group to Another System

You can move an entire LVM volume group to another system. It is recommended that you use the `vgexport` and `vgimport` commands when you do this.

The `vgexport` command makes an inactive volume group inaccessible to the system, which allows you to detach its physical volumes. The `vgimport` command makes a volume group accessible to a machine again after the `vgexport` command has made it inactive.

To move a volume group from one system to another, perform the following steps:

1. Make sure that no users are accessing files on the active volumes in the volume group, then unmount the logical volumes.
2. Use the `-a n` argument of the `vgchange` command to mark the volume group as inactive, which prevents any further activity on the volume group.
3. Use the `vgexport` command to export the volume group. This prevents it from being accessed by the system from which you are removing it.

After you export the volume group, the physical volume will show up as being in an exported volume group when you execute the `pvscan` command, as in the following example.

```
[root@tng3-1]# pvscan
PV /dev/sda1  is in exported VG myvg [17.15 GB / 7.15 GB free]
PV /dev/sdc1  is in exported VG myvg [17.15 GB / 15.15 GB free]
PV /dev/sdd1  is in exported VG myvg [17.15 GB / 15.15 GB free]
...
```

When the system is next shut down, you can unplug the disks that constitute the volume group and connect them to the new system.

4. When the disks are plugged into the new system, use the `vgimport` command to import the volume group, making it accessible to the new system.
5. Activate the volume group with the `-a y` argument of the `vgchange` command.
6. Mount the file system to make it available for use.

3.14. Recreating a Volume Group Directory

To recreate a volume group directory and logical volume special files, use the `vgmknodes` command. This command checks the LVM2 special files in the `/dev` directory that are needed for active logical volumes. It creates any special files that are missing removes unused ones.

You can incorporate the `vgmknodes` command into the `vgscan` command by specifying the `--mknodes` argument to the command.

4. Logical Volume Administration

This section describes the commands that perform the various aspects of logical volume administration.

4.1. Creating Logical Volumes

To create a logical volume, use the `lvcreate` command. You can create linear volumes, striped volumes, and mirrored volumes, as described in the following subsections.

If you do not specify a name for the logical volume, the default name `lvol#` is used where `#` is the internal number of the logical volume.

The following sections provide examples of logical volume creation for the three types of logical volumes you can create with LVM.

4.1.1. Creating Linear Volumes

When you create a logical volume, the logical volume is carved from a volume group using the free extents on the physical volumes that make up the volume group. Normally logical volumes use up any space available on the underlying physical volumes on a next-free basis. Modifying the logical volume frees and reallocates space in the physical volumes.

The following command creates a logical volume 10 gigabytes in size in the volume

group vg1.

```
lvcreate -L 10G vg1
```

The following command creates a 1500 megabyte linear logical volume named testlv in the volume group testvg, creating the block device /dev/testvg/testlv.

```
lvcreate -L1500 -ntestlv testvg
```

The following command creates a 50 gigabyte logical volume named gfslv from the free extents in volume group vg0.

```
lvcreate -L 50G -n gfslv vg0
```

You can use the -l argument of the lvcreate command to specify the size of the logical volume in extents. You can also use this argument to specify the percentage of the volume group to use for the logical volume. The following command creates a logical volume called mylv that uses 60% of the total space in volume group testvol.

```
lvcreate -l 60%VG -n mylv testvg
```

You can also use the -l argument of the lvcreate command to specify the percentage of the remaining free space in a volume group as the size of the logical volume. The following command creates a logical volume called yourlv that uses all of the unallocated space in the volume group testvol.

```
lvcreate -l 100%FREE -n yourlv testvg
```

You can use -l argument of the lvcreate command to create a logical volume that uses the entire volume group. Another way to create a logical volume that uses the entire volume group is to use the vgdisplay command to find the "Total PE" size and to use those results as input to the the lvcreate command.

The following commands create a logical volume called mylv that fills the volume

group named testvg.

```
# vdisplay testvg | grep "Total PE"
Total PE          10230
# lvcreate -l 10230 testvg -n mylv
```

The underlying physical volumes used to create a logical volume can be important if the physical volume needs to be removed, so you may need to consider this possibility when you create the logical volume. For information on removing a physical volume from a volume group, see [Section 3.5, “Removing Physical Volumes from a Volume Group”](#).

To create a logical volume to be allocated from a specific physical volume in the volume group, specify the physical volume or volumes at the end of the `lvcreate` command line. The following command creates a logical volume named `testlv` in volume group `testvg` allocated from the physical volume `/dev/sdg1`,

```
lvcreate -L 1500 -ntestlv testvg /dev/sdg1
```

You can specify which extents of a physical volume are to be used for a logical volume. The following example creates a linear logical volume out of extents 0 through 25 of physical volume `/dev/sda1` and extents 50 through 125 of physical volume `/dev/sdb1` in volume group `testvg`.

```
lvcreate -l 100 -n testlv testvg /dev/sda1:0-25 /dev/sdb1:50-125
```

The following example creates a linear logical volume out of extents 0 through 25 of physical volume `/dev/sda1` and then continues laying out the logical volume at extent 100.

```
lvcreate -l 100 -n testlv testvg /dev/sda1:0-25:100-
```

The default policy for how the extents of a logical volume are allocated is `inherit`, which applies the same policy as for the volume group. These policies can be changed using the `lvchange` command. For information on allocation policies, see [Section 3.1, “Creating Volume Groups”](#).

4.1.2. Creating Striped Volumes

For large sequential reads and writes, creating a striped logical volume can improve the efficiency of the data I/O. For general information about striped volumes, see [Section 3.2, “Striped Logical Volumes”](#).

When you create a striped logical volume, you specify the number of stripes with the `-i` argument of the `lvcreate` command. This determines over how many physical volumes the logical volume will be striped. The number of stripes cannot be greater than the number of physical volumes in the volume group (unless the `--alloc anywhere` argument is used).

The stripe size should be tuned to a power of 2 between 4kB and 512kB, and matched to the application's I/O that is using the striped volume. The `-l` argument of the `lvcreate` command specifies the stripe size in kilobytes.

If the underlying physical devices that make up a striped logical volume are different sizes, the maximum size of the striped volume is determined by the smallest underlying device. For example, in a two-legged stripe, the maximum size is twice the size of the smaller device. In a three-legged stripe, the maximum size is three times the size of the smallest device.

The following command creates a striped logical volume across 2 physical volumes with a stride of 64kB. The logical volume is 50 gigabytes in size, is named `gfslv`, and is carved out of volume group `vg0`.

```
lvcreate -L 50G -i2 -l64 -n gfslv vg0
```

As with linear volumes, you can specify the extents of the physical volume that you are using for the stripe. The following command creates a striped volume 100 extents in size that stripes across two physical volumes, is named `stripelv` and is in volume group `testvg`. The stripe will use sectors 0-50 of `/dev/sda1` and sectors 50-100 of `/dev/sdb1`.

```
# lvcreate -l 100 -i2 -nstripelv testvg /dev/sda1:0-50 /dev/sdb1:50-100
Using default stripesize 64.00 KB
Logical volume "stripelv" created
```

4.1.3. Creating Mirrored Volumes

When you create a mirrored volume, you specify the number of copies of the data to make with the `-m` argument of the `lvcreate` command. Specifying `-m1` creates one mirror, which yields two copies of the file system: a linear logical volume plus one copy. Similarly, specifying `-m2` creates two mirrors, yielding three copies of the file system.

The following command creates a mirrored logical volume with a single mirror. The volume is 50 gigabytes in size, is named `mirrorlv`, and is carved out of volume group `vg0`:

```
lvcreate -L 50G -m1 -n gfslv vg0
```

An LVM mirror divides the device being copied into regions that, by default, are 512KB in size. You can use the `-R` argument to specify the region size in MB. LVM maintains a small log which it uses to keep track of which regions are in sync with the mirror or mirrors. By default, this log is kept on disk, which keeps it persistent across reboots. You can specify instead that this log be kept in memory with the `--corelog` argument; this eliminates the need for an extra log device, but it requires that the entire mirror be resynchronized at every reboot.

The following command creates a mirrored logical volume from the volume group `bigvg`. The logical is named `ondiskmirvol` and has a single mirror. The volume is 12MB in size and keeps the mirror log in memory.

```
# lvcreate -L 12MB -m1 --corelog -n ondiskmirvol bigvg
Logical volume "ondiskmirvol" created
```

When a mirror is created, the mirror regions are synchronized. For large mirror components, the sync process may take a long time. When you are creating a new mirror that does not need to be revived, you can specify the `nosync` argument to indicate that an initial synchronization from the first device is not required.

You can specify which devices to use for the mirror logs and log, and which extents of the devices to use. To force the log onto a particular disk, specify exactly one extent on the disk on which it will be placed. LVM does not necessarily respect the order in which devices are listed in the command line. If any physical volumes are listed that is the only space on which allocation will take place. Any physical extents included in the list that are already allocated will get ignored.

The following command creates a mirrored logical volume with a single mirror. The volume is 500 megabytes in size, it is named `mirrorlv`, and it is carved out of volume group `vg0`. The first leg of the mirror is on device `/dev/sda1`, the second leg of the mirror is on device `/dev/sdb1`, and the mirror log is on `/dev/sdc1`.

```
lvcreate -L 500M -m1 -n mirrorlv vg0 /dev/sda1 /dev/sdb1 /dev/sdc1
```

The following command creates a mirrored logical volume with a single mirror. The volume is 500 megabytes in size, it is named `mirrorlv`, and it is carved out of volume group `vg0`. The first leg of the mirror is on extents 0 through 499 of device `/dev/sda1`, the second leg of the mirror is on extents 0 through 499 of device `/dev/sdb1`, and the mirror log starts on extent 0 of device `/dev/sdc1`. These are 1MB extents. If any of the specified extents have already been allocated, they will be ignored.

```
lvcreate -L 500M -m1 -n mirrorlv vg0 /dev/sda1:0-499 /dev/sdb1:0-499 /dev/sdc1:0
```

4.1.4. Changing Mirrored Volume Configuration

You can convert a logical volume from a mirrored volume to a linear volume or from a linear volume to a mirrored volume with the `lvconvert` command. You can also use this command to reconfigure other mirror parameters of an existing logical volume, such as `corelog`.

When you convert a logical volume to a mirrored volume, you are basically creating mirror legs for an existing volume. This means that your volume group must contain the devices and space for the mirror legs and for the mirror log.

If you lose a leg of a mirror, LVM converts the volume to a linear volume so that you still have access to the volume, without the mirror redundancy. After you replace the leg, you can use the `lvconvert` command to restore the mirror. This procedure is provided in [Section 3, “Recovering from LVM Mirror Failure”](#).

The following command converts the linear logical volume `vg00/lvol1` to a mirrored logical volume.

```
lvconvert -m1 vg00/lvol1
```

The following command converts the mirrored logical volume `vg00/lvol1` to a linear logical volume, removing the mirror leg.

```
lvconvert -m0 vg00/lvol1
```

4.2. Persistent Device Numbers

Major and minor device numbers are allocated dynamically at module load. Some applications work best if the block device always is activated with the same device (major and minor) number. You can specify these with the `lvcreate` and the `lvchange` commands by using the following arguments:

```
--persistent y --major major --minor minor
```

Use a large minor number to be sure that it hasn't already been allocated to another device dynamically.

If you are exporting a file system using NFS, specifying the `fsid` parameter in the exports file may avoid the need to set a persistent device number within LVM.

4.3. Resizing Logical Volumes

To change the size of a logical volume, use the `lvreduce` command. If the logical volume contains a file system, be sure to reduce the file system first (or use the LVM GUI) so that the logical volume is always at least as large as the file system expects it to be.

The following command reduces the size of logical volume `lvol1` in volume group `vg00` by 3 logical extents.

```
lvreduce -l -3 vg00/lvol1
```

4.4. Changing the Parameters of a Logical Volume Group

To change the parameters of a logical volume, use the `lvchange` command. For a listing of the parameters you can change, see the `lvchange(8)` man page.

You can use the `lvchange` command to activate and deactivate logical volumes. To activate and deactivate all the logical volumes in a volume group at the same time, use the `vgchange` command, as described in [Section 3.6, “Changing the Parameters of a Volume Group”](#).

The following command changes the permission on volume `lv01` in volume group `vg00` to be read-only.

```
lvchange -pr vg00/lv01
```

4.5. Renaming Logical Volumes

To rename an existing logical volume, use the `lvrename` command.

Either of the following commands renames logical volume `lvold` in volume group `vg02` to `lvnew`.

```
lvrename /dev/vg02/lvold /dev/vg02/lvnew
```

```
lvrename vg02 lvold lvnew
```

For more information on activating logical volumes on individual nodes in a cluster, see [Section 8, “Activating Logical Volumes on Individual Nodes in a Cluster”](#).

4.6. Removing Logical Volumes

To remove an inactive logical volume, use the `lvremove` command. You must close a logical volume with the `umount` command before it can be removed. In addition, in a clustered environment you must deactivate a logical volume before it can be removed.

If the logical volume is currently mounted, unmount the volume before removing it.

The following command removes the logical volume `/dev/testvg/testlv.` from the volume group `testvg`. Note that in this case the logical volume has not been deactivated.

```
[root@tng3-1 lvm]# lvremove /dev/testvg/testlv
Do you really want to remove active logical volume "testlv"? [y/n]: y
Logical volume "testlv" successfully removed
```

You could explicitly deactivate the logical volume before removing it with the `lvchange -an` command, in which case you would not see the prompt verifying whether you want to remove an active logical volume.

4.7. Displaying Logical Volumes

There are three commands you can use to display properties of LVM logical volumes: `lvs`, `lvdisplay`, and `lvscan`.

The `lvs` command provides logical volume information in a configurable form, displaying one line per logical volume. The `lvs` command provides a great deal of format control, and is useful for scripting. For information on using the `lvs` command to customize your output, see [Section 9, “Customized Reporting for LVM”](#).

The `lvdisplay` command displays logical volume properties (such as size, layout, and mapping) in a fixed format.

The following command shows the attributes of `lv02` in `vg00`. If snapshot logical volumes have been created for this original logical volume, this command shows a list of all snapshot logical volumes and their status (active or inactive) as well.

```
lvdisplay -v /dev/vg00/lv02
```

The `lvscan` command scans for all logical volumes in the system and lists them, as in the following example.

```
# lvscan
ACTIVE          '/dev/vg0/gfslv' [1.46 GB] inherit
```

4.8. Growing Logical Volumes

To increase the size of a logical volume, use the `lvextend` command.

After extending the logical volume, you will need to increase the size of the associated file system to match.

Chapter 4. LVM Administration...

When you extend the logical volume, you can indicate how much you want to extend the volume, or how large you want it to be after you extend it.

The following command extends the logical volume `/dev/myvg/homevol` to 12 gigabytes.

```
# lvextend -L12G /dev/myvg/homevol  
lvextend -- extending logical volume "/dev/myvg/homevol" to 12 GB  
lvextend -- doing automatic backup of volume group "myvg"  
lvextend -- logical volume "/dev/myvg/homevol" successfully extended
```

The following command adds another gigabyte to the logical volume `/dev/myvg/homevol`.

```
# lvextend -L+1G /dev/myvg/homevol  
lvextend -- extending logical volume "/dev/myvg/homevol" to 13 GB  
lvextend -- doing automatic backup of volume group "myvg"  
lvextend -- logical volume "/dev/myvg/homevol" successfully extended
```

As with the `lvcreate` command, you can use the `-l` argument of the `lvextend` command to specify the number of extents by which to increase the size of the logical volume. You can also use this argument to specify a percentage of the volume group, or a percentage of the remaining free space in the volume group. The following command extends the logical volume called `testlv` to fill all of the unallocated space in the volume group `myvg`.

```
[root@tng3-1 ~]# lvextend -l +100%FREE /dev/myvg/testlv  
Extending logical volume testlv to 68.59 GB  
Logical volume testlv successfully resized
```

After you have extended the logical volume it is necessary to increase the file system size to match.

By default, most file system resizing tools will increase the size of the file system to be the size of the underlying logical volume so you do not need to worry about specifying the same size for each of the two commands.

4.9. Extending a Striped Volume

In order to increase the size of a striped logical volume, there must be enough free space on the underlying physical volumes that make up the volume group to support the stripe. For example, if you have a two-way stripe that uses up an entire volume group, adding a single physical volume to the volume group will not enable you to extend the stripe. Instead, you must add at least two physical volumes to the volume group.

For example, consider a volume group `vg` that consists of two underlying physical volumes, as displayed with the following `vgs` command.

```
# vgs
VG #PV #LV #SN Attr VSize VFree
vg 2 0 0 wz--n- 271.31G 271.31G
```

You can create a stripe using the entire amount of space in the volume group.

```
# lvcreate -n stripe1 -L 271.31G -i 2 vg
Using default stripesize 64.00 KB
Rounding up size to full physical extent 271.31 GB
Logical volume "stripe1" created
# lvs -a -o +devices
LV VG Attr LSize Origin Snap% Move Log Copy% Devices
stripe1 vg -wi-a- 271.31G /dev/sda1(0),/dev/sdb1(0)
```

Note that the volume group now has no more free space.

```
# vgs
VG #PV #LV #SN Attr VSize VFree
vg 2 1 0 wz--n- 271.31G 0
```

The following command adds another physical volume to the volume group, which then has 135G of additional space.

```
# vgextend vg /dev/sdc1
Volume group "vg" successfully extended
# vgs
```

```
VG #PV #LV #SN Attr VSize VFree
vg  3  1  0 wz--n- 406.97G 135.66G
```

At this point you cannot extend the striped logical volume to the full size of the volume group, because two underlying devices are needed in order to stripe the data.

```
# lvextend vg/stripe1 -L 406G
Using stripesize of last segment 64.00 KB
Extending logical volume stripe1 to 406.00 GB
Insufficient suitable allocatable extents for logical volume stripe1: 34480
more required
```

To extend the striped logical volume, add another physical volume and then extend the logical volume. In this example, having added two physical volumes to the volume group we can extend the logical volume 5A to the full size of the volume group.

```
# vgextend vg /dev/sdd1
Volume group "vg" successfully extended
# vgs
VG #PV #LV #SN Attr VSize VFree
vg  4  1  0 wz--n- 542.62G 271.31G
# lvextend vg/stripe1 -L 542G
Using stripesize of last segment 64.00 KB
Extending logical volume stripe1 to 542.00 GB
Logical volume stripe1 successfully resized
```

If you do not have enough underlying physical devices to extend the striped logical volume, it is possible to extend the volume anyway if it does not matter that the extension is not striped, which may result in uneven performance. When adding space to the logical volume, the default operation is to use the same striping parameters of the last segment of the existing logical volume, but you can override those parameters. The following example extends the existing striped logical volume to use the remaining free space after the initial `lvextend` command fails.

```
# lvextend vg/stripe1 -L 406G
```

```
Using stripesize of last segment 64.00 KB
Extending logical volume stripe1 to 406.00 GB
Insufficient suitable allocatable extents for logical volume stripe1: 34480
more required
# lvextend -iL -l+100%FREE vg/stripe1
```

4.10. Shrinking Logical Volumes

To reduce the size of a logical volume, first unmount the file system. You can then use the `lvreduce` command to shrink the volume. After shrinking the volume, remount the file system.



Caution

It is important to reduce the size of the file system or whatever is residing in the volume before shrinking the volume itself, otherwise you risk losing data.

Shrinking a logical volume frees some of the volume group to be allocated to other logical volumes in the volume group.

The following example reduces the size of logical volume `lv01` in volume group `vg00` by 3 logical extents.

```
lvreduce -l -3 vg00/lv01
```

5. Creating Snapshot Volumes

Use the `-s` argument of the `lvcreate` command to create a snapshot volume. A snapshot volume is writeable.

LVM snapshots are not cluster-aware, so they require exclusive access to a volume. For information on activating logical volumes on individual nodes in a cluster, see [Section 8, “Activating Logical Volumes on Individual Nodes in a Cluster”](#).

The following command creates a snapshot logical volume that is 100 megabytes in size named `/dev/vg00/snap`. This creates a snapshot of the origin logical volume named `/dev/vg00/lv01`. If the original logical volume contains a file system, you can

Chapter 4. LVM Administration...

mount the snapshot logical volume on an arbitrary directory in order to access the contents of the file system to run a backup while the original file system continues to get updated.

```
lvcreate --size 100M --snapshot --name snap /dev/vg00/lvol1
```

After you create a snapshot logical volume, specifying the origin volume on the `lvdisplay` command yields output that includes a list of all snapshot logical volumes and their status (active or inactive).

The following example shows the status of the logical volume `/dev/new_vg/lvol0`, for which a snapshot volume `/dev/new_vg/newvgsnap` has been created.

```
# lvdisplay /dev/new_vg/lvol0
--- Logical volume ---
LV Name           /dev/new_vg/lvol0
VG Name           new_vg
LV UUID           LBy1Tz-sr23-Ojsl-LT03-nHLC-y8XW-EhCI78
LV Write Access   read/write
LV snapshot status source of
                  /dev/new_vg/newvgsnap1 [active]
LV Status         available
# open            0
LV Size           52.00 MB
Current LE        13
Segments          1
Allocation        inherit
Read ahead sectors 0
Block device      253:2
```

The `lvs` command, by default, displays the origin volume and the current percentage of the snapshot volume being used for each snapshot volume. The following example shows the default output for the `lvs` command for a system that includes the logical volume `/dev/new_vg/lvol0`, for which a snapshot volume `/dev/new_vg/newvgsnap` has been created.

```
# lvs
LV      VG   Attr  LSize  Origin Snap%  Move Log Copy%
lvol0   new_vg owi-a- 52.00M
```

```
newvgsnap1 new_vg swi-a- 8.00M lvol0 0.20
```



Note

Because the snapshot increases in size as the origin volume changes, it is important to monitor the percentage of the snapshot volume regularly with the `lvs` command to be sure it does not fill. A snapshot that is 100% full is lost completely, as write to unchanged parts of the origin would be unable to succeed without corrupting the snapshot.

6. Controlling LVM Device Scans with Filters

At startup, the `vgscan` command is run to scan the block devices on the system looking for LVM labels, to determine which of them are physical volumes and to read the metadata and build up a list of volume groups. The names of the physical volumes are stored in the cache file of each node in the system, `/etc/lvm/.cache`. Subsequent commands may read that file to avoid rescanning.

You can control which devices LVM scans by setting up filters in the `lvm.conf` configuration file. The filters consist of a series of simple regular expressions that get applied to the device names in the `/dev` directory to decide whether to accept or reject each block device found.

The following examples show the use of filters to control which devices LVM scans. Note that some of these examples do not necessarily represent best practice, as the regular expressions are matched freely against the complete pathname. For example, `a/loop/` is equivalent to `a/*.*/` and would match `/dev/solooperation/lvol1`.

The following filter adds all discovered devices, which is the default behavior as there is no filter configured in the configuration file:

```
filter = [ "a./" ]
```

The following filter removes the `cdrom` device in order to avoid delays if the drive contains no media:

```
filter = [ "r|/dev/cdrom|" ]
```

The following filter adds all loop and removes all other block devices:

```
filter = [ "a/loop.*/", "r.*/" ]
```

The following filter adds all loop and IDE and removes all other block devices:

```
filter =[ "a|loop.*|", "a|/dev/hd.*|", "r|.*)" ]
```

The following filter adds just partition 8 on the first IDE drive and removes all other block devices:

```
filter = [ "a|^/dev/hda8$|", "r.*/" ]
```

For more information on the `lvm.conf` file, see [Appendix B, The LVM Configuration Files](#) and the `lvm.conf(5)` man page.

7. Online Data Relocation

You can move data while the system is in use with the `pvmove` command.

The `pvmove` command breaks up the data to be moved into sections and creates a temporary mirror to move each section. For more information on the operation of the `pvmove` command, see the `pvmove(8)` man page.

Because the `pvmove` command uses mirroring, it is not cluster-aware and needs exclusive access to a volume. For information on activating logical volumes on individual nodes in a cluster, see [Section 8, “Activating Logical Volumes on Individual Nodes in a Cluster”](#).

The following command moves all allocated space off the physical volume `/dev/sdc1` to other free physical volumes in the volume group:

```
pvmove /dev/sdc1
```

The following command moves just the extents of the logical volume MyLV.

```
pvmove -n MyLV /dev/sdc1
```

Since the `pvmove` command can take a long time to execute, you may want to run the command in the background to avoid display of progress updates in the foreground. The following command moves all extents allocated to the physical volume `/dev/sdc1` over to `/dev/sdf1` in the background.

```
pvmove -b /dev/sdc1 /dev/sdf1
```

The following command reports the progress of the move as a percentage at five second intervals.

```
pvmove -i5 /dev/sdd1
```

8. Activating Logical Volumes on Individual Nodes in a Cluster

If you have LVM installed in a cluster environment, you may at times need to activate logical volumes exclusively on one node. For example, the `pvmove` command is not cluster-aware and needs exclusive access to a volume. LVM snapshots require exclusive access to a volume as well.

To activate logical volumes exclusively on one node, use the `lvchange -aey` command. Alternatively, you can use `lvchange -aly` command to activate logical volumes only on the local node but not exclusively. You can later activate them on additional nodes concurrently.

You can also activate logical volumes on individual nodes by using LVM tags, which are described in [Appendix C, LVM Object Tags](#). You can also specify activation of nodes in the configuration file, which is described in [Appendix B, The LVM Configuration Files](#).

9. Customized Reporting for LVM

You can produce concise and customizable reports of LVM objects with the `pvs`, `lvs`, and `vgs` commands. The reports that these commands generate include one line of output for each object. Each line contains an ordered list of fields of properties related to the object. There are five ways to select the objects to be reported: by physical volume, volume group, logical volume, physical volume segment, and logical volume segment.

The following sections provide:

- A summary of command arguments you can use to control the format of the generated report.
- A list of the fields you can select for each LVM object.
- A summary of command arguments you can use to sort the generated report.
- Instructions for specifying the units of the report output.

9.1. Format Control

Whether you use the `pvs`, `lvs`, or `vgs` command determines the default set of fields displayed and the sort order. You can control the output of these commands with the following arguments:

- You can change what fields are displayed to something other than the default by using the `-o` argument. For example, the following output is the default display for the `pvs` command (which displays information about physical volumes).

```
# pvs
PV      VG   Fmt Attr PSize PFree
/dev/sdb1 new_vg lvm2 a- 17.14G 17.14G
/dev/sdc1 new_vg lvm2 a- 17.14G 17.09G
/dev/sdd1 new_vg lvm2 a- 17.14G 17.14G
```

The following command displays only the physical volume name and size.

```
# pvs -o pv_name,pv_size
PV      PSize
/dev/sdb1 17.14G
```



```
/dev/sdc1 17.14G
/dev/sdd1 17.14G
```

- You can append a field to the output with the plus sign (+), which is used in combination with the -o argument.

The following example displays the UUID of the physical volume in addition to the default fields.

```
# pvs -o +pv_uuid
PV      VG   Fmt Attr PSize PFree PV UUID
/dev/sdb1 new_vg lvm2 a- 17.14G 17.14G onFF2w-1fLC-ughJ-D9eB-M7iv-6XqA-dqGeXY
/dev/sdc1 new_vg lvm2 a- 17.14G 17.09G Joqlch-yWSj-kuEn-ldwM-01S9-XO8M-mcpsVe
/dev/sdd1 new_vg lvm2 a- 17.14G 17.14G yvfvZK-Cf31-j75k-dECm-0RZ3-0dGW-tUqkCS
```

- Adding the -v argument to a command includes some extra fields. For example, the pvs -v command will display the DevSize and PV UUID fields in addition to the default fields.

```
# pvs -v
Scanning for physical volume names
PV      VG   Fmt Attr PSize PFree DevSize PV UUID
/dev/sdb1 new_vg lvm2 a- 17.14G 17.14G 17.14G
onFF2w-1fLC-ughJ-D9eB-M7iv-6XqA-dqGeXY
/dev/sdc1 new_vg lvm2 a- 17.14G 17.09G 17.14G
Joqlch-yWSj-kuEn-ldwM-01S9-XO8M-mcpsVe
/dev/sdd1 new_vg lvm2 a- 17.14G 17.14G 17.14G
yvfvZK-Cf31-j75k-dECm-0RZ3-0dGW-tUqkCS
```

- The --noheadings argument suppresses the headings line. This can be useful for writing scripts.

The following example uses the --noheadings argument in combination with the pv_name argument, which will generate a list of all physical volumes.

```
# pvs --noheadings -o pv_name
/dev/sdb1
/dev/sdc1
```

```
/dev/sdd1
```

- The `--separator separator` argument uses `separator` to separate each field. This can be useful in a script if you are running a `grep` command on the output.

The following example separates the default output fields of the `pvs` command with an equals sign (=).

```
# pvs --separator =
PV=VG=Fmt=Attr=PSize=PFree
/dev/sdb1=new_vg=lv2=a-=17.14G=17.14G
/dev/sdc1=new_vg=lv2=a-=17.14G=17.09G
/dev/sdd1=new_vg=lv2=a-=17.14G=17.14G
```

To keep the fields aligned when using the `separator` argument, use the `separator` argument in conjunction with the `--aligned` argument.

```
# pvs --separator = --aligned
PV      =VG   =Fmt =Attr=PSize =PFree
/dev/sdb1 =new_vg=lv2=a- =17.14G=17.14G
/dev/sdc1 =new_vg=lv2=a- =17.14G=17.09G
/dev/sdd1 =new_vg=lv2=a- =17.14G=17.14G
```

You can use the `-P` argument of the `lvs` or `vgs` command to display information about a failed volume that would otherwise not appear in the output. For information on the output this argument yields, see [Section 2, “Displaying Information on Failed Devices”](#).

For a full listing of display arguments, see the `pvs(8)`, `vgs(8)` and `lvs(8)` man pages.

Volume group fields can be mixed with either physical volume (and physical volume segment) fields or with logical volume (and logical volume segment) fields, but physical volume and logical volume fields cannot be mixed. For example, the following command will display one line of output for each physical volume.

```
# vgs -o +pv_name
VG   #PV #LV #SN Attr  VSize VFree PV
new_vg 3  1  0 wz--n- 51.42G 51.37G /dev/sdc1
```

```
new_vg 3 1 0 wz--n- 51.42G 51.37G /dev/sdd1
new_vg 3 1 0 wz--n- 51.42G 51.37G /dev/sdb1
```

9.2. Object Selection

This section provides a series of tables that list the information you can display about the LVM objects with the `pvs`, `vgs`, and `lvs` commands.

For convenience, a field name prefix can be dropped if it matches the default for the command. For example, with the `pvs` command, `name` means `pv_name`, but with the `vgs` command, `name` is interpreted as `vg_name`.

Executing the following command is the equivalent of executing `pvs -o pv_free`.

```
# pvs -o free
PFree
17.14G
17.09G
17.14G
```

The `pvs` Command

Table 4.1, “`pvs` Display Fields” lists the display arguments of the `pvs` command, along with the field name as it appears in the header display and a description of the field.

Argument	Header	Description
<code>dev_size</code>	DevSize	The size of the underlying device on which the physical volume was created
<code>pe_start</code>	1st PE	Offset to the start of the first physical extent in the underlying device
<code>pv_attr</code>	Attr	Status of the physical volume: (a)llocatable or e(x)ported.
<code>pv_fmt</code>	Fmt	The metadata format of the physical volume (<code>lvm2</code> or <code>lvm1</code>)
<code>pv_free</code>	PFree	The free space remaining on the physical volume
<code>pv_name</code>	PV	The physical volume name
<code>pv_pe_alloc_count</code>	Alloc	Number of used physical extents

Argument	Header	Description
pv_pe_count	PE	Number of physical extents
pvseg_size	SSize	The segment size of the physical volume
pvseg_start	Start	The starting physical extent of the physical volume segment
pv_size	PSize	The size of the physical volume
pv_tags	PV Tags	LVM tags attached to the physical volume
pv_used	Used	The amount of space currently used on the physical volume
pv_uuid	PV UUID	The UUID of the physical volume

Table 4.1. pvs Display Fields

The `pvs` command displays the following fields by default: `pv_name`, `vg_name`, `pv_fmt`, `pv_attr`, `pv_size`, `pv_free`. The display is sorted by `pv_name`.

```
# pvs
PV      VG   Fmt Attr PSize PFree
/dev/sdb1 new_vg lvm2 a- 17.14G 17.14G
/dev/sdc1 new_vg lvm2 a- 17.14G 17.09G
/dev/sdd1 new_vg lvm2 a- 17.14G 17.13G
```

Using the `-v` argument with the `pvs` command adds the following fields to the default display: `dev_size`, `pv_uuid`.

```
# pvs -v
Scanning for physical volume names
PV      VG   Fmt Attr PSize PFree DevSize PV UUID
/dev/sdb1 new_vg lvm2 a- 17.14G 17.14G 17.14G
onFF2w-1fLC-ughJ-D9eB-M7iv-6XqA-dqGeXY
/dev/sdc1 new_vg lvm2 a- 17.14G 17.09G 17.14G
Jqqlch-yWSj-kuEn-ldwM-01S9-XO8M-mcpsVe
/dev/sdd1 new_vg lvm2 a- 17.14G 17.13G 17.14G
yvfvZK-Cf31-j75k-dECm-0RZ3-0dGW-tUqkCS
```

You can use the `--segments` argument of the `pvs` command to display information

about each physical volume segment. A segment is a group of extents. A segment view can be useful if you want to see whether your logical volume is fragmented.

The `pvs --segments` command displays the following fields by default: `pv_name`, `vg_name`, `pv_fmt`, `pv_attr`, `pv_size`, `pv_free`, `pvseg_start`, `pvseg_size`. The display is sorted by `pv_name` and `pvseg_size` within the physical volume.

```
# pvs --segments
PV      VG      Fmt Attr PSize PFree Start SSize
/dev/hda2 VolGroup00 lvm2 a- 37.16G 32.00M 0 1172
/dev/hda2 VolGroup00 lvm2 a- 37.16G 32.00M 1172 16
/dev/hda2 VolGroup00 lvm2 a- 37.16G 32.00M 1188 1
/dev/sda1 vg      lvm2 a- 17.14G 16.75G 0 26
/dev/sda1 vg      lvm2 a- 17.14G 16.75G 26 24
/dev/sda1 vg      lvm2 a- 17.14G 16.75G 50 26
/dev/sda1 vg      lvm2 a- 17.14G 16.75G 76 24
/dev/sda1 vg      lvm2 a- 17.14G 16.75G 100 26
/dev/sda1 vg      lvm2 a- 17.14G 16.75G 126 24
/dev/sda1 vg      lvm2 a- 17.14G 16.75G 150 22
/dev/sda1 vg      lvm2 a- 17.14G 16.75G 172 4217
/dev/sdb1 vg      lvm2 a- 17.14G 17.14G 0 4389
/dev/sdc1 vg      lvm2 a- 17.14G 17.14G 0 4389
/dev/sdd1 vg      lvm2 a- 17.14G 17.14G 0 4389
/dev/sde1 vg      lvm2 a- 17.14G 17.14G 0 4389
/dev/sdf1 vg      lvm2 a- 17.14G 17.14G 0 4389
/dev/sdg1 vg      lvm2 a- 17.14G 17.14G 0 4389
```

You can use the `pvs -a` command to see devices detected by LVM that have not been initialized as LVM physical volumes.

```
# pvs -a
PV      VG      Fmt Attr PSize PFree
/dev/VolGroup00/LogVol01      -- 0 0
/dev/new_vg/lvol0             -- 0 0
/dev/ram                      -- 0 0
/dev/ram0                     -- 0 0
/dev/ram2                     -- 0 0
/dev/ram3                     -- 0 0
/dev/ram4                     -- 0 0
/dev/ram5                     -- 0 0
/dev/ram6                     -- 0 0
/dev/root                     -- 0 0
```

```

/dev/sda          --    0    0
/dev/sdb          --    0    0
/dev/sdb1        new_vg lvm2 a- 17.14G 17.14G
/dev/sdc          --    0    0
/dev/sdc1        new_vg lvm2 a- 17.14G 17.09G
/dev/sdd          --    0    0
/dev/sdd1        new_vg lvm2 a- 17.14G 17.14G

```

The vgs Command

Table 4.2, “vgs Display Fields” lists the display arguments of the vgs command, along with the field name as it appears in the header display and a description of the field.

Argument	Header	Description
lv_count	#LV	The number of logical volumes the volume group contains
max_lv	MaxLV	The maximum number of logical volumes allowed in the volume group (0 if unlimited)
max_pv	MaxPV	The maximum number of physical volumes allowed in the volume group (0 if unlimited)
pv_count	#PV	The number of physical volumes that define the volume group
snap_count	#SN	The number of snapshots the volume group contains
vg_attr	Attr	Status of the volume group: (w)riteable, (r)eadonly, resi(z)eable, e(x)ported, (p)artial and (c)lustered.
vg_extent_count	#Ext	The number of physical extents in the volume group
vg_extent_size	Ext	The size of the physical extents in the volume group
vg_fmt	Fmt	The metadata format of the volume group (lvm2 or lvm1)
vg_free	VFree	Size of the free space remaining in the volume group
vg_free_count	Free	Number of free physical extents in the volume group
vg_name	VG	The volume group name
vg_seqno	Seq	Number representing the revision of the volume group
vg_size	VSize	The size of the volume group
vg_sysid	SYS ID	LVM1 System ID

Argument	Header	Description
vg_tags	VG Tags	LVM tags attached to the volume group
vg_uuid	VG UUID	The UUID of the volume group

Table 4.2. vgs Display Fields

The `vgs` command displays the following fields by default: `vg_name`, `pv_count`, `lv_count`, `snap_count`, `vg_attr`, `vg_size`, `vg_free`. The display is sorted by `vg_name`.

```
# vgs
VG   #PV #LV #SN Attr  VSize VFree
new_vg 3  1  1 wz--n- 51.42G 51.36G
```

Using the `-v` argument with the `vgs` command adds the following fields to the default display: `vg_extent_size`, `vg_uuid`.

```
# vgs -v
Finding all volume groups
Finding volume group "new_vg"
VG   Attr Ext #PV #LV #SN VSize VFree VG UUID
new_vg wz--n- 4.00M 3  1  1 51.42G 51.36G
jxQJ0a-ZKk0-OpMO-0118-nlwO-wwqd-fD5D32
```

The lvs Command

Table 4.3, “`lvs Display Fields`” lists the display arguments of the `lvs` command, along with the field name as it appears in the header display and a description of the field.

Argument	Header	Description
chunksize chunk_size	Chunk	Unit size in a snapshot volume
copy_percent	Copy%	The synchronization percentage of a mirrored logical volume; also used when physical extents are being moved with the <code>pv_move</code> command
devices	Devices	The underlying devices that make up the logical

Argument	Header	Description
		volume: the physical volumes, logical volumes, and start physical extents and logical extents
lv_attr	Attr	<p>The status of the logical volume. The logical volume attribute bits are as follows:</p> <p>Bit 1: Volume type: (m)irrored, (M)irrored without initial sync, (o)rigin, (p)vmove, (s)napshot, invalid (S)napshot, (v)irtual</p> <p>Bit2: Permissions: (w)riteable, (r)ead-only</p> <p>Bit 3: Allocation policy: (c)ontiguous, (n)ormal, (a)nywhere, (i)nherited. This is capitalized if the volume is currently locked against allocation changes, for example while executing the pvmove command.</p> <p>Bit 4: fixed (m)inor</p> <p>Bit 5 State: (a)ctive, (s)uspended, (I)nvalid snapshot, invalid (S)uspended snapshot, mapped (d)evice present without tables, mapped device present with (i)nactive table</p> <p>Bit 6: device (o)pen</p>
lv_kernel_major	KMaj	Actual major device number of the logical volume (-1 if inactive)
lv_kernel_minor	KMIN	Actual minor device number of the logical volume (-1 if inactive)
lv_major	Maj	The persistent major device number of the logical volume (-1 if not specified)
lv_minor	Min	The persistent minor device number of the logical volume (-1 if not specified)
lv_name	LV	The name of the logical volume
lv_size	LSize	The size of the logical volume
lv_tags	LV Tags	LVM tags attached to the logical volume
lv_uuid	LV UUID	The UUID of the logical volume.
mirror_log	Log	Device on which the mirror log resides
modules	Modules	Corresponding kernel device-mapper target necessary to use this logical volume
move_pv	Move	Source physical volume of a temporary logical volume created with the pvmove command

Argument	Header	Description
origin	Origin	The origin device of a snapshot volume
regionsize region_size	Region	The unit size of a mirrored logical volume
seg_count	#Seg	The number of segments in the logical volume
seg_size	SSize	The size of the segments in the logical volume
seg_start	Start	Offset of the segment in the logical volume
seg_tags	Seg Tags	LVM tags attached to the segments of the logical volume
segtype	Type	The segment type of a logical volume (for example: mirror, striped, linear)
snap_percent	Snap%	Current percentage of a snapshot volume that is in use
stripes	#Str	Number of stripes or mirrors in a logical volume
stripesize stripe_size	Stripe	Unit size of the stripe in a striped logical volume

Table 4.3. lvs Display Fields

The `lvs` command displays the following fields by default: `lv_name`, `vg_name`, `lv_attr`, `lv_size`, `origin`, `snap_percent`, `move_pv`, `mirror_log`, `copy_percent`. The default display is sorted by `vg_name` and `lv_name` within the volume group.

```
# lvs
LV      VG      Attr  LSize Origin Snap%  Move Log Copy%
lv0l0   new_vg owi-a- 52.00M
newvg1  new_vg swi-a- 8.00M lv0l0  0.20
```

Using the `-v` argument with the `lvs` command adds the following fields to the default display: `seg_count`, `lv_major`, `lv_minor`, `lv_kernel_major`, `lv_kernel_minor`, `lv_uuid`.

```
# lvs -v
Finding all logical volumes
LV      VG      #Seg Attr  LSize Maj Min KMaj KMin Origin Snap%  Move Copy%  Log LV
```

```
UUID
lv0l0   new_vg   1 owi-a- 52.00M -1 -1 253 3
LBy1Tz-sr23-Ojsl-LT03-nHLC-y8XW-EhCl78
newvgsnap1 new_vg   1 swi-a- 8.00M -1 -1 253 5   lv0l0   0.20
1ye10U-1clu-o79k-20h2-ZGF0-qCJm-Cfbslx
```

You can use the `--segments` argument of the `lvs` command to display information with default columns that emphasize the segment information. When you use the `segments` argument, the `seg` prefix is optional. The `lvs --segments` command displays the following fields by default: `lv_name`, `vg_name`, `lv_attr`, `stripes`, `segtype`, `seg_size`. The default display is sorted by `vg_name`, `lv_name` within the volume group, and `seg_start` within the logical volume. If the logical volumes were fragmented, the output from this command would show that.

```
# lvs --segments
LV   VG   Attr #Str Type  SSize
LogVol00 VolGroup00 -wi-ao 1 linear 36.62G
LogVol01 VolGroup00 -wi-ao 1 linear 512.00M
lv   vg   -wi-a- 1 linear 104.00M
lv   vg   -wi-a- 1 linear 104.00M
lv   vg   -wi-a- 1 linear 104.00M
lv   vg   -wi-a- 1 linear 88.00M
```

Using the `-v` argument with the `lvs --segments` command adds the following fields to the default display: `seg_start`, `stripesize`, `chunksz`.

```
# lvs -v --segments
Finding all logical volumes
LV   VG   Attr Start SSize #Str Type  Stripe Chunk
lv0l0   new_vg owi-a- 0 52.00M 1 linear 0 0
newvgsnap1 new_vg swi-a- 0 8.00M 1 linear 0 8.00K
```

The following example shows the default output of the `lvs` command on a system with one logical volume configured, followed by the default output of the `lvs` command with the `segments` argument specified.

```
# lvs
LV   VG   Attr LSize Origin Snap% Move Log Copy%
```

```
lv00 new_vg -wi-a- 52.00M
# lvs --segments
LV VG Attr #Str Type SSize
lv00 new_vg -wi-a- 1 linear 52.00M
```

9.3. Sorting LVM Reports

Normally the entire output of the `lvs`, `vgs`, or `pvs` command has to be generated and stored internally before it can be sorted and columns aligned correctly. You can specify the `--unbuffered` argument to display unsorted output as soon as it is generated.

To specify an alternative ordered list of columns to sort on, use the `-O` argument of any of the reporting commands. It is not necessary to include these fields within the output itself.

The following example shows the output of the `pvs` command that displays the physical volume name, size, and free space.

```
# pvs -o pv_name,pv_size,pv_free
PV      PSize PFree
/dev/sdb1 17.14G 17.14G
/dev/sdc1 17.14G 17.09G
/dev/sdd1 17.14G 17.14G
```

The following example shows the same output, sorted by the free space field.

```
# pvs -o pv_name,pv_size,pv_free -O pv_free
PV      PSize PFree
/dev/sdc1 17.14G 17.09G
/dev/sdd1 17.14G 17.14G
/dev/sdb1 17.14G 17.14G
```

The following example shows that you do not need to display the field on which you are sorting.

```
# pvs -o pv_name,pv_size -O pv_free
PV      PSize
/dev/sdc1 17.14G
```

```
/dev/sdd1 17.14G
/dev/sdb1 17.14G
```

To display a reverse sort, precede a field you specify after the `-O` argument with the `-` character.

```
# pvs -o pv_name,pv_size,pv_free -O -pv_free
PV      PSize PFree
/dev/sdd1 17.14G 17.14G
/dev/sdb1 17.14G 17.14G
/dev/sdc1 17.14G 17.09G
```

9.4. Specifying Units

To specify the unit for the LVM report display, use the `--units` argument of the report command. You can specify (b)ytes, (k)ilobytes, (m)egabytes, (g)igabytes, (t)erabytes, (e)xabytes, (p)etabytes, and (h)uman-readable. The default display is human-readable. You can override the default by setting the units parameter in the global section of the `lvm.conf` file.

The following example specifies the output of the `pvs` command in megabytes rather than the default gigabytes.

```
# pvs --units m
PV      VG      Fmt Attr PSize   PFree
/dev/sda1    lvm2 -- 17555.40M 17555.40M
/dev/sdb1  new_vg lvm2 a- 17552.00M 17552.00M
/dev/sdc1  new_vg lvm2 a- 17552.00M 17500.00M
/dev/sdd1  new_vg lvm2 a- 17552.00M 17552.00M
```

By default, units are displayed in powers of 2 (multiples of 1024). You can specify that units be displayed in multiples of 1000 by capitalizing the unit specification (B, K, M, G, T, H).

The following command displays the output as a multiple of 1024, the default behavior.

```
# pvs
```

```
PV      VG   Fmt Attr PSize PFree
/dev/sdb1 new_vg lvm2 a- 17.14G 17.14G
/dev/sdc1 new_vg lvm2 a- 17.14G 17.09G
/dev/sdd1 new_vg lvm2 a- 17.14G 17.14G
```

The following command displays the output as a multiple of 1000.

```
# pvs --units G
PV      VG   Fmt Attr PSize PFree
/dev/sdb1 new_vg lvm2 a- 18.40G 18.40G
/dev/sdc1 new_vg lvm2 a- 18.40G 18.35G
/dev/sdd1 new_vg lvm2 a- 18.40G 18.40G
```

You can also specify (s)ectors (defined as 512 bytes) or custom units.

The following example displays the output of the `pvs` command as a number of sectors.

```
# pvs --units s
PV      VG   Fmt Attr PSize  PFree
/dev/sdb1 new_vg lvm2 a- 35946496S 35946496S
/dev/sdc1 new_vg lvm2 a- 35946496S 35840000S
/dev/sdd1 new_vg lvm2 a- 35946496S 35946496S
```

The following example displays the output of the `pvs` command in units of 4 megabytes.

```
# pvs --units 4m
PV      VG   Fmt Attr PSize  PFree
/dev/sdb1 new_vg lvm2 a- 4388.00U 4388.00U
/dev/sdc1 new_vg lvm2 a- 4388.00U 4375.00U
/dev/sdd1 new_vg lvm2 a- 4388.00U 4388.00U
```

LVM Configuration Examples

This chapter provides some basic LVM configuration examples.

1. Creating an LVM Logical Volume on Three Disks

This example creates an LVM logical volume called `new_logical_volume` that consists of the disks at `/dev/sda1`, `/dev/sdb1`, and `/dev/sdc1`.

1.1. Creating the Physical Volumes

To use disks in a volume group, you label them as LVM physical volumes.



Caution

This command destroys any data on `/dev/sda1`, `/dev/sdb1`, and `/dev/sdc1`.

```
[root@tng3-1 ~]# pvcreate /dev/sda1 /dev/sdb1 /dev/sdc1  
Physical volume "/dev/sda1" successfully created  
Physical volume "/dev/sdb1" successfully created  
Physical volume "/dev/sdc1" successfully created
```

1.2. Creating the Volume Group

The following command creates the volume group `new_vol_group`.

```
[root@tng3-1 ~]# vgcreate new_vol_group /dev/sda1 /dev/sdb1 /dev/sdc1  
Volume group "new_vol_group" successfully created
```

You can use the `vgs` command to display the attributes of the new volume group.

```
[root@tng3-1 ~]# vgs  
VG          #PV #LV #SN Attr   VSize VFree  
new_vol_group 3  0  0 wz--n- 51.45G 51.45G
```

1.3. Creating the Logical Volume

The following command creates the logical volume `new_logical_volume` from the volume group `new_vol_group`. This example creates a logical volume that uses 2GB of the volume group.

```
[root@tng3-1 ~]# lvcreate -L2G -n new_logical_volume new_vol_group  
Logical volume "new_logical_volume" created
```

1.4. Creating the File System

The following command creates a GFS file system on the logical volume.

```
[root@tng3-1 ~]# gfs_mkfs -plock_nolock -j 1  
/dev/new_vol_group/new_logical_volume  
This will destroy any data on /dev/new_vol_group/new_logical_volume.  
  
Are you sure you want to proceed? [y/n] y  
  
Device:           /dev/new_vol_group/new_logical_volume  
Blocksize:       4096  
Filesystem Size:  491460  
Journals:        1  
Resource Groups: 8  
Locking Protocol: lock_nolock  
Lock Table:  
  
Syncing...  
All Done
```

The following commands mount the logical volume and report the file system disk space usage.

```
[root@tng3-1 ~]# mount /dev/new_vol_group/new_logical_volume /mnt  
[root@tng3-1 ~]# df  
Filesystem      1K-blocks  Used Available Use% Mounted on  
/dev/new_vol_group/new_logical_volume
```



```
1965840    20 1965820 1% /mnt
```

2. Creating a Striped Logical Volume

This example creates an LVM striped logical volume called `striped_logical_volume` that stripes data across the disks at `/dev/sda1`, `/dev/sdb1`, and `/dev/sdc1`.

2.1. Creating the Physical Volumes

Label the disks you will use in the volume groups as LVM physical volumes.



Caution

This command destroys any data on `/dev/sda1`, `/dev/sdb1`, and `/dev/sdc1`.

```
[root@tng3-1 ~]# pvcreate /dev/sda1 /dev/sdb1 /dev/sdc1
Physical volume "/dev/sda1" successfully created
Physical volume "/dev/sdb1" successfully created
Physical volume "/dev/sdc1" successfully created
```

2.2. Creating the Volume Group

The following command creates the volume group `striped_vol_group`.

```
[root@tng3-1 ~]# vgcreate striped_vol_group /dev/sda1 /dev/sdb1 /dev/sdc1
Volume group "striped_vol_group" successfully created
```

You can use the `vgs` command to display the attributes of the new volume group.

```
[root@tng3-1 ~]# vgs
VG          #PV #LV #SN Attr   VSize VFree
striped_vol_group 3  0  0 wz--n- 51.45G 51.45G
```

2.3. Creating the Logical Volume

The following command creates the striped logical volume `striped_logical_volume` from the volume group `striped_vol_group`. This example creates a logical volume that is 2 gigabytes in size, with three stripes and a stripe size of 4 kilobytes.

```
[root@tng3-1 ~]# lvcreate -i3 -l4 -L2G -nstriped_logical_volume striped_vol_group
Rounding size (512 extents) up to stripe boundary size (513 extents)
Logical volume "striped_logical_volume" created
```

2.4. Creating the File System

The following command creates a GFS file system on the logical volume.

```
[root@tng3-1 ~]# gfs_mkfs -plock_nolock -j 1
/dev/striped_vol_group/striped_logical_volume
This will destroy any data on /dev/striped_vol_group/striped_logical_volume.

Are you sure you want to proceed? [y/n] y

Device:          /dev/striped_vol_group/striped_logical_volume
Blocksize:      4096
Filesystem Size: 492484
Journals:       1
Resource Groups: 8
Locking Protocol: lock_nolock
Lock Table:

Syncing...
All Done
```

The following commands mount the logical volume and report the file system disk space usage.

```
[root@tng3-1 ~]# mount /dev/striped_vol_group/striped_logical_volume /mnt
[root@tng3-1 ~]# df
Filesystem      1K-blocks    Used Available Use% Mounted on
/dev/mapper/VolGroup00-LogVol00
                13902624 1656776 11528232 13% /
/dev/hda1       101086     10787   85080 12% /boot
tmpfs           127880      0 127880  0% /dev/shm
```

```
/dev/striped_vol_group/striped_logical_volume
1969936    20 1969916  1% /mnt
```

3. Splitting a Volume Group

In this example, an existing volume group consists of three physical volumes. If there is enough unused space on the physical volumes, a new volume group can be created without adding new disks.

In the initial set up, the logical volume `mylv` is carved from the volume group `myvol`, which in turn consists of the three physical volumes, `/dev/sda1`, `/dev/sdb1`, and `/dev/sdc1`.

After completing this procedure, the volume group `myvg` will consist of `/dev/sda1` and `/dev/sdb1`. A second volume group, `yourvg`, will consist of `/dev/sdc1`.

3.1. Determining Free Space

You can use the `pvscan` command to determine how much free space is currently available in the volume group.

```
[root@tng3-1 ~]# pvscan
PV /dev/sda1  VG myvg  lvm2 [17.15 GB / 0   free]
PV /dev/sdb1  VG myvg  lvm2 [17.15 GB / 12.15 GB free]
PV /dev/sdc1  VG myvg  lvm2 [17.15 GB / 15.80 GB free]
Total: 3 [51.45 GB] / in use: 3 [51.45 GB] / in no VG: 0 [0   ]
```

3.2. Moving the Data

You can move all the used physical extents in `/dev/sdc1` to `/dev/sdb1` with the `pvmove` command. The `pvmove` command can take a long time to execute.

```
[root@tng3-1 ~]# pvmove /dev/sdc1 /dev/sdb1
/dev/sdc1: Moved: 14.7%
/dev/sdc1: Moved: 30.3%
/dev/sdc1: Moved: 45.7%
/dev/sdc1: Moved: 61.0%
/dev/sdc1: Moved: 76.6%
/dev/sdc1: Moved: 92.2%
/dev/sdc1: Moved: 100.0%
```

After moving the data, you can see that all of the space on /dev/sdc1 is free.

```
[root@tng3-1 ~]# pvscan
PV /dev/sda1  VG myvg  lvm2 [17.15 GB / 0   free]
PV /dev/sdb1  VG myvg  lvm2 [17.15 GB / 10.80 GB free]
PV /dev/sdc1  VG myvg  lvm2 [17.15 GB / 17.15 GB free]
Total: 3 [51.45 GB] / in use: 3 [51.45 GB] / in no VG: 0 [0   ]
```

3.3. Splitting the Volume Group

To create the new volume group `yourvg`, use the `vgsplit` command to split the volume group `myvg`.

Before you can split the volume group, the logical volume must be inactive. If the file system is mounted, you must unmount the file system before deactivating the logical volume.

You can deactivate the logical volumes with the `lvchange` command or the `vgchange` command. The following command deactivates the logical volume `mylv` and then splits the volume group `yourvg` from the volume group `myvg`, moving the physical volume `/dev/sdc1` into the new volume group `yourvg`.

```
[root@tng3-1 ~]# lvchange -a n /dev/myvg/mylv
[root@tng3-1 ~]# vgsplit myvg yourvg /dev/sdc1
Volume group "yourvg" successfully split from "myvg"
```

You can use the `vgs` command to see the attributes of the two volume groups.

```
[root@tng3-1 ~]# vgs
VG   #PV #LV #SN Attr   VSize VFree
myvg  2  1  0 wz--n- 34.30G 10.80G
yourvg 1  0  0 wz--n- 17.15G 17.15G
```

3.4. Creating the New Logical Volume

After creating the new volume group, you can create the new logical volume `yourlv`.

```
[root@tng3-1 ~]# lvcreate -L5G -n yourlv yourvg  
Logical volume "yourlv" created
```

3.5. Making a File System and Mounting the New Logical Volume

You can make a file system on the new logical volume and mount it.

```
[root@tng3-1 ~]# gfs_mkfs -plock_nolock -j 1 /dev/yourvg/yourlv  
This will destroy any data on /dev/yourvg/yourlv.  
  
Are you sure you want to proceed? [y/n] y  
  
Device:           /dev/yourvg/yourlv  
Blocksize:        4096  
Filesystem Size:  1277816  
Journals:         1  
Resource Groups:  20  
Locking Protocol: lock_nolock  
Lock Table:  
  
Syncing...  
All Done  
  
[root@tng3-1 ~]# mount /dev/yourvg/yourlv /mnt
```

3.6. Activating and Mounting the Original Logical Volume

Since you had to deactivate the logical volume mylv, you need to activate it again before you can mount it.

```
root@tng3-1 ~]# lvchange -a y mylv  
  
[root@tng3-1 ~]# mount /dev/myvg/mylv /mnt  
[root@tng3-1 ~]# df  
Filesystem      1K-blocks    Used Available Use% Mounted on  
/dev/yourvg/yourlv 24507776    32 24507744  1% /mnt
```

```
/dev/myvg/mylv      24507776      32 24507744  1% /mnt
```

4. Removing a Disk from a Logical Volume

This example shows how you can remove a disk from an existing logical volume, either to replace the disk or to use the disk as part of a different volume. In order to remove a disk, you must first move the extents on the LVM physical volume to a different disk or set of disks.

4.1. Moving Extents to Existing Physical Volumes

In this example, the logical volume is distributed across four physical volumes in the volume group myvg.

```
[root@tng3-1]# pvs -o+pv_used
PV      VG  Fmt Attr PSize PFree Used
/dev/sda1 myvg lvm2 a- 17.15G 12.15G 5.00G
/dev/sdb1 myvg lvm2 a- 17.15G 12.15G 5.00G
/dev/sdc1 myvg lvm2 a- 17.15G 12.15G 5.00G
/dev/sdd1 myvg lvm2 a- 17.15G  2.15G 15.00G
```

We want to move the extents off of /dev/sdb1 so that we can remove it from the volume group.

If there are enough free extents on the other physical volumes in the volume group, you can execute the `pvmove` command on the device you want to remove with no other options and the extents will be distributed to the other devices.

```
[root@tng3-1 ~]# pvmove /dev/sdb1
/dev/sdb1: Moved: 2.0%
...
/dev/sdb1: Moved: 79.2%
...
/dev/sdb1: Moved: 100.0%
```

After the `pvmove` command has finished executing, the distribution of extents is as follows:

```
[root@tng3-1]# pvs -o+pv_used
PV      VG  Fmt Attr PSize PFree Used
/dev/sda1 myvg lvm2 a- 17.15G 7.15G 10.00G
/dev/sdb1 myvg lvm2 a- 17.15G 17.15G 0
/dev/sdc1 myvg lvm2 a- 17.15G 12.15G 5.00G
/dev/sdd1 myvg lvm2 a- 17.15G 2.15G 15.00G
```

Use the `vgreduce` command to remove the physical volume `/dev/sdb1` from the volume group.

```
[root@tng3-1 ~]# vgreduce myvg /dev/sdb1
Removed "/dev/sdb1" from volume group "myvg"
[root@tng3-1 ~]# pvs
PV      VG  Fmt Attr PSize PFree
/dev/sda1 myvg lvm2 a- 17.15G 7.15G
/dev/sdb1  lvm2 -- 17.15G 17.15G
/dev/sdc1 myvg lvm2 a- 17.15G 12.15G
/dev/sdd1 myvg lvm2 a- 17.15G 2.15G
```

The disk can now be physically removed or allocated to other users.

4.2. Moving Extents to a New Disk

In this example, the logical volume is distributed across three physical volumes in the volume group `myvg` as follows:

```
[root@tng3-1]# pvs -o+pv_used
PV      VG  Fmt Attr PSize PFree Used
/dev/sda1 myvg lvm2 a- 17.15G 7.15G 10.00G
/dev/sdb1 myvg lvm2 a- 17.15G 15.15G 2.00G
/dev/sdc1 myvg lvm2 a- 17.15G 15.15G 2.00G
```

We want to move the extents of `/dev/sdb1` to a new device, `/dev/sdd1`.

4.2.1. Creating the New Physical Volume

Create a new physical volume from `/dev/sdd1`.

```
[root@tng3-1 ~]# pvcreate /dev/sdd1
Physical volume "/dev/sdd1" successfully created
```

4.2.2. Adding the New Physical Volume to the Volume Group

Add /dev/sdd1 to the existing volume group myvg.

```
[root@tng3-1 ~]# vgextend myvg /dev/sdd1
Volume group "myvg" successfully extended
[root@tng3-1]# pvs -o+pv_used
PV      VG  Fmt Attr PSize PFree Used
/dev/sda1  myvg lvm2 a- 17.15G 7.15G 10.00G
/dev/sdb1  myvg lvm2 a- 17.15G 15.15G 2.00G
/dev/sdc1  myvg lvm2 a- 17.15G 15.15G 2.00G
/dev/sdd1  myvg lvm2 a- 17.15G 17.15G 0
```

4.2.3. Moving the Data

Use the pvmove command to move the data from /dev/sdb1 to /dev/sdd1.

```
[root@tng3-1 ~]# pvmove /dev/sdb1 /dev/sdd1
/dev/sdb1: Moved: 10.0%
...
/dev/sdb1: Moved: 79.7%
...
/dev/sdb1: Moved: 100.0%

[root@tng3-1]# pvs -o+pv_used
PV      VG  Fmt Attr PSize PFree Used
/dev/sda1  myvg lvm2 a- 17.15G 7.15G 10.00G
/dev/sdb1  myvg lvm2 a- 17.15G 17.15G 0
/dev/sdc1  myvg lvm2 a- 17.15G 15.15G 2.00G
/dev/sdd1  myvg lvm2 a- 17.15G 15.15G 2.00G
```

4.2.4. Removing the Old Physical Volume from the Volume Group

After you have moved the data off `/dev/sdb1`, you can remove it from the volume group.

```
[root@tng3-1 ~]# vgreduce myvg /dev/sdb1  
Removed "/dev/sdb1" from volume group "myvg"
```

You can now reallocate the disk to another volume group or remove the disk from the system.

LVM Troubleshooting

This chapter provide instructions for troubleshooting a variety of LVM issues.

1. Troubleshooting Diagnostics

If a command is not working as expected, you can gather diagnostics in the following ways:

- Use the `-v`, `-vv`, `-vvv`, or `-vvvv` argument of any command for increasingly verbose levels of output.
- If the problem is related to the logical volume activation, set `'activation = 1'` in the `'log'` section of the configuration file and run the command with the `-vvvv` argument. After you have finished examining this output be sure to reset this parameter to `0`, to avoid possible problems with the machine locking during low memory situations.
- Run the `lvmdump` command, which provides and information dump for diagnostic purposes. For information, see the `lvmdump(8)` man page.
- Execute the `lvs -v`, `pvs -a` or `dmsetup info -c` command for additional system information.
- Examine the last backup of the metadata in the `/etc/lvm/backup` file and archived versions in the `/etc/lvm/archive` file.
- Check the current configuration information by running the `lvm dumpconfig` command.
- Check the `.cache` file in the `/etc/lvm` directory for a record of which devices have physical volumes on them.

2. Displaying Information on Failed Devices

You can use the `-P` argument of the `lvs` or `vgs` command to display information about a failed volume that would otherwise not appear in the output. This argument permits some operations even though the metadata is not completely consistent internally. For example, if one of the devices that made up the volume group `vg` failed, the `vgs` command might show the following output.

Chapter 6. LVM Troubleshooting

```
[root@link-07 tmp]# vgs -o +devices
Volume group "vg" not found
```

If you specify the `-P` argument of the `vgs` command, the volume group is still unusable but you can see more information about the failed device.

```
[root@link-07 tmp]# vgs -P -o +devices
Partial mode. Incomplete volume groups will be activated read-only.
VG  #PV #LV #SN Attr  VSize VFree Devices
vg   9  2  0 rz-pn- 2.11T 2.07T unknown device(0)
vg   9  2  0 rz-pn- 2.11T 2.07T unknown device(5120),/dev/sda1(0)
```

In this example, the failed device caused both a linear and a striped logical volume in the volume group to fail. The `lvs` command without the `-P` argument shows the following output.

```
[root@link-07 tmp]# lvs -a -o +devices
Volume group "vg" not found
```

Using the `-P` argument shows the logical volumes that have failed.

```
[root@link-07 tmp]# lvs -P -a -o +devices
Partial mode. Incomplete volume groups will be activated read-only.
LV   VG  Attr  LSize  Origin Snap%  Move Log Copy%  Devices
linear vg  -wi-a- 20.00G                               unknown device(0)
stripe vg  -wi-a- 20.00G                               unknown device(5120),/dev/sda1(0)
```

The following examples show the output of the `pvs` and `lvs` commands with the `-P` argument specified when a leg of a mirrored logical volume has failed.

```
root@link-08 ~]# vgs -a -o +devices -P
Partial mode. Incomplete volume groups will be activated read-only.
VG  #PV #LV #SN Attr  VSize VFree Devices
corey  4  4  0 rz-pnc 1.58T 1.34T my_mirror_mimage_0(0),my_mirror_mimage_1(0)
corey  4  4  0 rz-pnc 1.58T 1.34T /dev/sdd1(0)
```

```
corey 4 4 0 rz-pnc 1.58T 1.34T unknown device(0)
corey 4 4 0 rz-pnc 1.58T 1.34T /dev/sdb1(0)
```

```
[root@link-08 ~]# lvs -a -o +devices -P
Partial mode. Incomplete volume groups will be activated read-only.
LV          VG   Attr  LSize  Origin Snap%  Move Log       Copy%  Devices
my_mirror   corey mwi-a- 120.00G          my_mirror_mlog 1.95
my_mirror_mimage_0(0),my_mirror_mimage_1(0)
[my_mirror_mimage_0] corey lwi-ao 120.00G          unknown
device(0)
[my_mirror_mimage_1] corey lwi-ao 120.00G          /dev/sdb1(0)
[my_mirror_mlog]   corey lwi-ao 4.00M           /dev/sdd1(0)
```

3. Recovering from LVM Mirror Failure

This section provides an example of recovering from a situation where one leg of an LVM mirrored volume fails because the underlying device for a physical volume goes down. When a mirror leg fails, LVM converts the mirrored volume into a linear volume, which continues to operate as before but without the mirrored redundancy. At that point, you can add a new disk device to the system to use as a replacement physical device and rebuild the mirror.

The following command creates the physical volumes which will be used for the mirror.

```
[root@link-08 ~]# pvcreate /dev/sd[abcdefgh][12]
Physical volume "/dev/sda1" successfully created
Physical volume "/dev/sda2" successfully created
Physical volume "/dev/sdb1" successfully created
Physical volume "/dev/sdb2" successfully created
Physical volume "/dev/sdc1" successfully created
Physical volume "/dev/sdc2" successfully created
Physical volume "/dev/sdd1" successfully created
Physical volume "/dev/sdd2" successfully created
Physical volume "/dev/sde1" successfully created
Physical volume "/dev/sde2" successfully created
Physical volume "/dev/sdf1" successfully created
Physical volume "/dev/sdf2" successfully created
Physical volume "/dev/sdg1" successfully created
Physical volume "/dev/sdg2" successfully created
```

Chapter 6. LVM Troubleshooting

```
Physical volume "/dev/sdh1" successfully created
Physical volume "/dev/sdh2" successfully created
```

The following commands creates the volume group `vg` and the mirrored volume groups.

```
[root@link-08 ~]# vgcreate vg /dev/sd[abcdefgh][12]
Volume group "vg" successfully created
[root@link-08 ~]# lvcreate -L 750M -n groupfs -m 1 vg /dev/sda1 /dev/sdb1
/dev/sdc1
Rounding up size to full physical extent 752.00 MB
Logical volume "groupfs" created
```

You can use the `lvs` command to verify the layout of the mirrored volume and the underlying devices for the mirror leg and the mirror log. Note that in the first example the mirror is not yet completely synced; you should wait until the `Copy%` field displays `100.00` before continuing.

```
[root@link-08 ~]# lvs -a -o +devices
LV          VG Attr LSize  Origin Snap% Move Log          Copy% Devices
groupfs     vg  mwi-a- 752.00M                groups_mlog 21.28
groupfs_mimage_0(0),groupfs_mimage_1(0)
[groupfs_mimage_0] vg  iwi-ao 752.00M                /dev/sda1(0)
[groupfs_mimage_1] vg  iwi-ao 752.00M                /dev/sdb1(0)
[groupfs_mlog]  vg  lwi-ao 4.00M                  /dev/sdc1(0)

[root@link-08 ~]# lvs -a -o +devices
LV          VG Attr LSize  Origin Snap% Move Log          Copy% Devices
groupfs     vg  mwi-a- 752.00M                groups_mlog 100.00
groupfs_mimage_0(0),groupfs_mimage_1(0)
[groupfs_mimage_0] vg  iwi-ao 752.00M                /dev/sda1(0)
[groupfs_mimage_1] vg  iwi-ao 752.00M                /dev/sdb1(0)
[groupfs_mlog]  vg  lwi-ao 4.00M  i                /dev/sdc1(0)
```

In this example, the primary leg of the mirror `/dev/sda1` fails. Any write activity to the mirrored volume causes LVM to detect the failed mirror. When this occurs, LVM converts the mirror into a single linear volume. In this case, to trigger the conversion, we execute a `dd` command

```
[root@link-08 ~]# dd if=/dev/zero of=/dev/vg/groupfs count=10
10+0 records in
10+0 records out
```

You can use the `lvs` command to verify that the device is now a linear device. Because of the failed disk, I/O errors occur.

```
[root@link-08 ~]# lvs -a -o +devices
/dev/sda1: read failed after 0 of 2048 at 0: Input/output error
/dev/sda2: read failed after 0 of 2048 at 0: Input/output error
LV   VG   Attr LSize  Origin Snap%  Move Log Copy%  Devices
groupfs vg  -wi-a- 752.00M                /dev/sdb1(0)
```

At this point you should still be able to use the logical volume, but there will be no mirror redundancy.

To rebuild the mirrored volume, you replace the broken drive and recreate the physical volume. If you use the same disk rather than replacing it with a new one, you will see "inconsistent" warnings when you run the `pvcreate` command.

```
[root@link-08 ~]# pvcreate /dev/sda[12]
Physical volume "/dev/sda1" successfully created
Physical volume "/dev/sda2" successfully created

[root@link-08 ~]# pvscan
PV /dev/sdb1  VG vg  lvm2 [67.83 GB / 67.10 GB free]
PV /dev/sdb2  VG vg  lvm2 [67.83 GB / 67.83 GB free]
PV /dev/sdc1  VG vg  lvm2 [67.83 GB / 67.83 GB free]
PV /dev/sdc2  VG vg  lvm2 [67.83 GB / 67.83 GB free]
PV /dev/sdd1  VG vg  lvm2 [67.83 GB / 67.83 GB free]
PV /dev/sdd2  VG vg  lvm2 [67.83 GB / 67.83 GB free]
PV /dev/sde1  VG vg  lvm2 [67.83 GB / 67.83 GB free]
PV /dev/sde2  VG vg  lvm2 [67.83 GB / 67.83 GB free]
PV /dev/sdf1  VG vg  lvm2 [67.83 GB / 67.83 GB free]
PV /dev/sdf2  VG vg  lvm2 [67.83 GB / 67.83 GB free]
PV /dev/sdg1  VG vg  lvm2 [67.83 GB / 67.83 GB free]
PV /dev/sdg2  VG vg  lvm2 [67.83 GB / 67.83 GB free]
PV /dev/sdh1  VG vg  lvm2 [67.83 GB / 67.83 GB free]
PV /dev/sdh2  VG vg  lvm2 [67.83 GB / 67.83 GB free]
```

Chapter 6. LVM Troubleshooting

```
PV /dev/sda1      lvm2 [603.94 GB]
PV /dev/sda2      lvm2 [603.94 GB]
Total: 16 [2.11 TB] / in use: 14 [949.65 GB] / in no VG: 2 [1.18 TB]
```

Next you extend the original volume group with the new physical volume.

```
[root@link-08 ~]# vgextend vg /dev/sda[12]
Volume group "vg" successfully extended

[root@link-08 ~]# pvscan
PV /dev/sdb1  VG vg  lvm2 [67.83 GB / 67.10 GB free]
PV /dev/sdb2  VG vg  lvm2 [67.83 GB / 67.83 GB free]
PV /dev/sdc1  VG vg  lvm2 [67.83 GB / 67.83 GB free]
PV /dev/sdc2  VG vg  lvm2 [67.83 GB / 67.83 GB free]
PV /dev/sdd1  VG vg  lvm2 [67.83 GB / 67.83 GB free]
PV /dev/sdd2  VG vg  lvm2 [67.83 GB / 67.83 GB free]
PV /dev/sde1  VG vg  lvm2 [67.83 GB / 67.83 GB free]
PV /dev/sde2  VG vg  lvm2 [67.83 GB / 67.83 GB free]
PV /dev/sdf1  VG vg  lvm2 [67.83 GB / 67.83 GB free]
PV /dev/sdf2  VG vg  lvm2 [67.83 GB / 67.83 GB free]
PV /dev/sdg1  VG vg  lvm2 [67.83 GB / 67.83 GB free]
PV /dev/sdg2  VG vg  lvm2 [67.83 GB / 67.83 GB free]
PV /dev/sdh1  VG vg  lvm2 [67.83 GB / 67.83 GB free]
PV /dev/sdh2  VG vg  lvm2 [67.83 GB / 67.83 GB free]
PV /dev/sda1  VG vg  lvm2 [603.93 GB / 603.93 GB free]
PV /dev/sda2  VG vg  lvm2 [603.93 GB / 603.93 GB free]
Total: 16 [2.11 TB] / in use: 16 [2.11 TB] / in no VG: 0 [0 ]
```

Convert the linear volume back to its original mirrored state.

```
[root@link-08 ~]# lvconvert -m 1 /dev/vg/groupfs /dev/sda1 /dev/sdb1 /dev/sdc1
Logical volume mirror converted.
```

You can use the `lvs` command to verify that the mirror is restored.

```
[root@link-08 ~]# lvs -a -o +devices
LV          VG  Attr  LSize  Origin Snap%  Move Log       Copy% Devices
groupfs     vg  mwi-a- 752.00M                groups_mlog 68.62
groupfs_mimage_0(0),groupfs_mimage_1(0)
```



```
[groupfs_mimage_0] vg iwi-ao 752.00M /dev/sdb1(0)
[groupfs_mimage_1] vg iwi-ao 752.00M /dev/sda1(0)
[groupfs_mlog] vg lwi-ao 4.00M /dev/sdc1(0)
```

4. Recovering Physical Volume Metadata

If the volume group metadata area of a physical volume is accidentally overwritten or otherwise destroyed, you will get an error message indicating that the metadata area is incorrect, or that the system was unable to find a physical volume with a particular UUID. You may be able to recover the data the physical volume by writing a new metadata area on the physical volume specifying the same UUID as the lost metadata.



Caution

You should not attempt this procedure with a working LVM logical volume. You will lose your data if you specify the incorrect UUID.

The following example shows the sort of output you may see if the metadata area is missing or corrupted.

```
[root@link-07 backup]# lvs -a -o +devices
Couldn't find device with uuid 'FmGRh3-zhok-iVl8-7qTD-S5BI-MAEN-NYM5Sk'.
Couldn't find all physical volumes for volume group VG.
Couldn't find device with uuid 'FmGRh3-zhok-iVl8-7qTD-S5BI-MAEN-NYM5Sk'.
Couldn't find all physical volumes for volume group VG.
...
```

You may be able to find the UUID for the physical volume that was overwritten by looking in the `/etc/lvm/archive` directory. Look in the file `VolumeGroupName_xxxx.vg` for the last known valid archived LVM metadata for that volume group.

Alternately, you may find that deactivating the volume and setting the partial (`-P`) argument will enable you to find the UUID of the missing corrupted physical volume.

```
[root@link-07 backup]# vgchange -an --partial
Partial mode. Incomplete volume groups will be activated read-only.
Couldn't find device with uuid 'FmGRh3-zhok-iVl8-7qTD-S5BI-MAEN-NYM5Sk'.
```

Chapter 6. LVM Troubleshooting

```
Couldn't find device with uuid 'FmGRh3-zhok-iVI8-7qTD-S5BI-MAEN-NYM5Sk'.  
...
```

Use the `--uuid` and `--restorefile` arguments of the `pvcreate` command to restore the physical volume. The following example labels the `/dev/sdh1` device as a physical volume with the UUID indicated above, `FmGRh3-zhok-iVI8-7qTD-S5BI-MAEN-NYM5Sk`. This command restores the physical volume label with the metadata information contained in `VG_00050.vg`, the most recent good archived metadata for volume group `.` The `restorefile` argument instructs the `pvcreate` command to make the new physical volume compatible with the old one on the volume group, ensuring that the the new metadata will not be placed where the old physical volume contained data (which could happen, for example, if the original `pvcreate` command had used the command line arguments that control metadata placement, or if the physical volume was originally created using a different version of the software that used different defaults). The `pvcreate` command overwrites only the LVM metadata areas and does not affect the existing data areas.

```
[root@link-07 backup]# pvcreate --uuid  
"FmGRh3-zhok-iVI8-7qTD-S5BI-MAEN-NYM5Sk" --restorefile  
/etc/lvm/archive/VG_00050.vg /dev/sdh1  
Physical volume "/dev/sdh1" successfully created
```

You can then use the `vgcfgrestore` command to restore the volume group's metadata.

```
[root@link-07 backup]# vgcfgrestore VG  
Restored volume group VG
```

You can now display the logical volumes.

```
[root@link-07 backup]# lvs -a -o +devices  
LV   VG   Attr  LSize  Origin Snap%  Move Log Copy%  Devices  
stripe VG   -wi--- 300.00G                /dev/sdh1 (0),/dev/sda1(0)  
stripe VG   -wi--- 300.00G                /dev/sdh1 (34728),/dev/sdb1(0)
```

The following commands activate the volumes and display the active volumes.

```
[root@link-07 backup]# lvchange -ay /dev/VG/stripe
[root@link-07 backup]# lvs -a -o +devices
LV   VG   Attr  LSize  Origin Snap%  Move Log Copy%  Devices
stripe VG -wi-a- 300.00G                /dev/sdh1 (0),/dev/sda1(0)
stripe VG -wi-a- 300.00G                /dev/sdh1 (34728),/dev/sdb1(0)
```

If the on-disk LVM metadata takes as least as much space as what overrode it, this command can recover the physical volume. If what overrode the metadata went past the metadata area, the data on the volume may have been affected. You might be able to use the `fsck` command to recover that data.

5. Replacing a Missing Physical Volume

If a physical volume fails or otherwise needs to be replaced, you can label a new physical volume to replace the one that has been lost in the existing volume group by following the same procedure as you would for recovering physical volume metadata, described in [Section 4, “Recovering Physical Volume Metadata”](#). You can use the `--partial` and `--verbose` arguments of the `vgdisplay` command to display the UUIDs and sizes of any physical volumes that are no longer present. If you wish to substitute another physical volume of the same size, you can use the `pvcreate` command with the `--restorefile` and `--uuid` arguments to initialize a new device with the same UUID as the missing physical volume. You can then use the `vgcfgrestore` command to restore the volume group's metadata.

6. Removing Lost Physical Volumes from a Volume Group

If you lose a physical volume, you can activate the remaining physical volumes in the volume group with the `--partial` argument of the `vgchange` command. You can remove all the logical volumes that used that physical volume from the volume group with the `--removemissing` argument of the `vgreduce` command.

It is recommended that you run the `vgreduce` command with the `--test` argument to verify what you will be destroying.

Like most LVM operations, the `vgreduce` command is reversible in a sense if you immediately use the `vgcfgrestore` command to restore the volume group metadata to its previous state. For example, if you used the `--removemissing` argument of the `vgreduce` command without the `--test` argument and find you have removed logical

volumes you wanted to keep, you can still replace the physical volume and use another `vgcfgrestore` command to return the volume group to its previous state.

7. Insufficient Free Extents for a Logical Volume

You may get the error message "Insufficient free extents" when creating a logical volume when you think you have enough extents based on the output of the `vgdisplay` or `vgs` commands. This is because these commands round figures to 2 decimal places to provide human-readable output. To specify exact size, use free physical extent count instead of some multiple of bytes to determine the size of the logical volume.

The `vgdisplay` command, by default, includes this line of output that indicates the free physical extents.

```
# vgdisplay
--- Volume group ---
...
Free PE / Size      8780 / 34.30 GB
```

Alternately, you can use the `vg_free_count` and `vg_extent_count` arguments of the `vgs` command to display the free extents and the total number of extents.

```
[root@tng3-1 ~]# vgs -o +vg_free_count,vg_extent_count
VG   #PV #LV #SN Attr   VSize VFree Free #Ext
testvg 2  0  0 wz--n- 34.30G 34.30G 8780 8780
```

With 8780 free physical extents, you can run the following command, using the lower-case `l` argument to use extents instead of bytes:

```
# lvcreate -l8780 -n testlv testvg
```

This uses all the free extents in the volume group.

```
# vgs -o +vg_free_count,vg_extent_count
VG   #PV #LV #SN Attr   VSize VFree Free #Ext
```

```
testvg 2 1 0 wz--n- 34.30G 0 0 8780
```

Alternately, you can extend the logical volume to use a percentage of the remaining free space in the volume group by using the `-l` argument of the `lvcreate` command. For information, see [Section 4.1.1, “Creating Linear Volumes”](#).

LVM Administration with the LVM GUI

In addition to the Command Line Interface (CLI), LVM provides a Graphical User Interface (GUI) which you can use to configure LVM logical volumes. You can bring up this utility by typing `system-config-lvm`. The LVM chapter of the Red Hat Enterprise Linux Deployment Guide provides step-by-step instructions for configuring an LVM logical volume using this utility.

In addition, the LVM GUI is available as part of the Conga management interface. For information on using the LVM GUI with Conga, see the online help for Conga.

Appendix A. The Device Mapper

The Device Mapper is a kernel driver that provides a generic framework for volume management. It provides a generic way of creating mapped devices, which may be used as logical volumes. It does not specifically know about volume groups or metadata formats.

The Device Mapper provides the foundation for a number of higher-level technologies. In addition to LVM, device-mapper multipath and the dmraid command use the Device Mapper.

The user interface to the Device Mapper is the `ioctl` system call.

LVM logical volumes are activated using the Device Mapper. Each logical volume is translated into a mapped device. Each segment translates into a line in the mapping table that describes the device. The Device Mapper provides linear mapping, striped mapping, and error mapping, amongst others. Two disks can be concatenated into one logical volume with a pair of linear mappings, one for each disk.

The `dmsetup` command is a command line wrapper for communication with the Device Mapper. It provides complete access to the `ioctl` commands through the `libdevmapper` command. For general system information about LVM devices, you may find the `dmsetup info` command to be useful.

For information about the options and capabilities of the `dmsetup` command, see the `dmsetup(8)` man page.

Appendix B. The LVM Configuration Files

LVM supports multiple configuration files. At system startup, the `lvm.conf` configuration file is loaded from the directory specified by the environment variable `LVM_SYSTEM_DIR`, which is set to `/etc/lvm` by default.

The `lvm.conf` file can specify additional configuration files to load. Settings in later files override settings from earlier ones. To display the settings in use after loading all the configuration files, execute the `lvm dumpconfig` command.

For information on loading additional configuration files, see [Section 2, “Host Tags”](#).

1. The LVM Configuration Files

The following files are used for LVM configuration:

`/etc/lvm/lvm.conf`

Central configuration file read by the tools.

`etc/lvm/lvm_hosttag.conf`

For each host tag, an extra configuration file is read if it exists: `lvm_hosttag.conf`. If that file defines new tags, then further configuration files will be appended to the list of files to read in. For information on host tags, see [Section 2, “Host Tags”](#).

In addition to the LVM configuration files, a system running LVM includes the following files that affect LVM system setup:

`/etc/lvm/.cache`

Device name filter cache file (configurable).

`/etc/lvm/backup/`

Directory for automatic volume group metadata backups (configurable).

`/etc/lvm/archive/`

Directory for automatic volume group metadata archives (configurable with regard to directory path and archive history depth).

/var/lock/lvm/

In single-host configuration, lock files to prevent parallel tool runs from corrupting the metadata; in a cluster, cluster-wide DLM is used.

2. Sample lvm.conf File

The following is a sample lvm.conf configuration file.

```
[root@tng3-1 lvm]# cat lvm.conf
# This is an example configuration file for the LVM2 system.
# It contains the default settings that would be used if there was no
# /etc/lvm/lvm.conf file.
#
# Refer to 'man lvm.conf' for further information including the file layout.
#
# To put this file in a different directory and override /etc/lvm set
# the environment variable LVM_SYSTEM_DIR before running the tools.

# This section allows you to configure which block devices should
# be used by the LVM system.
devices {

    # Where do you want your volume groups to appear ?
    dir = "/dev"

    # An array of directories that contain the device nodes you wish
    # to use with LVM2.
    scan = [ "/dev" ]

    # A filter that tells LVM2 to only use a restricted set of devices.
    # The filter consists of an array of regular expressions. These
    # expressions can be delimited by a character of your choice, and
    # prefixed with either an 'a' (for accept) or 'r' (for reject).
    # The first expression found to match a device name determines if
    # the device will be accepted or rejected (ignored). Devices that
    # don't match any patterns are accepted.

    # Be careful if there there are symbolic links or multiple filesystem
    # entries for the same device as each name is checked separately against
    # the list of patterns. The effect is that if any name matches any 'a'
    # pattern, the device is accepted; otherwise if any name matches any 'r'
    # pattern it is rejected; otherwise it is accepted.
```

```
# Don't have more than one filter line active at once: only one gets used.

# Run vgscan after you change this parameter to ensure that
# the cache file gets regenerated (see below).
# If it doesn't do what you expect, check the output of 'vgscan -vvvv'.

# By default we accept every block device:
# Steel Toe installed filter -- use this line while running tests
filter = [ "r/hda/", "r/disk/", "a./*" ]
# Steel Toe installed filter -- use this line when installing new kernels
#filter = [ "r/disk/", "a./*" ]

# Exclude the cdrom drive
# filter = [ "r|/dev/cdrom|" ]

# When testing I like to work with just loopback devices:
# filter = [ "a/loop/", "r./*" ]

# Or maybe all loops and ide drives except hdc:
# filter =[ "a|loop|", "r|/dev/hdc|", "a|/dev/ide|", "r|.*|" ]

# Use anchors if you want to be really specific
# filter = [ "a|^/dev/hda8$|", "r./*" ]

# The results of the filtering are cached on disk to avoid
# rescanning dud devices (which can take a very long time). By
# default this cache file is hidden in the /etc/lvm directory.
# It is safe to delete this file: the tools regenerate it.
cache = "/etc/lvm/.cache"

# You can turn off writing this cache file by setting this to 0.
write_cache_state = 1

# Advanced settings.

# List of pairs of additional acceptable block device types found
# in /proc/devices with maximum (non-zero) number of partitions.
# types = [ "fd", 16 ]

# If sysfs is mounted (2.6 kernels) restrict device scanning to
# the block devices it believes are valid.
# 1 enables; 0 disables.
```

```
sysfs_scan = 1

# By default, LVM2 will ignore devices used as components of
# software RAID (md) devices by looking for md superblocks.
# 1 enables; 0 disables.
md_component_detection = 1
}

# This section that allows you to configure the nature of the
# information that LVM2 reports.
log {

# Controls the messages sent to stdout or stderr.
# There are three levels of verbosity, 3 being the most verbose.
verbose = 0

# Should we send log messages through syslog?
# 1 is yes; 0 is no.
syslog = 1

# Should we log error and debug messages to a file?
# By default there is no log file.
#file = "/var/log/lvm2.log"

# Should we overwrite the log file each time the program is run?
# By default we append.
overwrite = 0

# What level of log messages should we send to the log file and/or syslog?
# There are 6 syslog-like log levels currently in use - 2 to 7 inclusive.
# 7 is the most verbose (LOG_DEBUG).
level = 0

# Format of output messages
# Whether or not (1 or 0) to indent messages according to their severity
indent = 1

# Whether or not (1 or 0) to display the command name on each line output
command_names = 0

# A prefix to use before the message text (but after the command name,
# if selected). Default is two spaces, so you can see/grep the severity
# of each message.
prefix = " "
```

```
# To make the messages look similar to the original LVM tools use:
# indent = 0
# command_names = 1
# prefix = "-- "

# Set this if you want log messages during activation.
# Don't use this in low memory situations (can deadlock).
# activation = 0
}

# Configuration of metadata backups and archiving. In LVM2 when we
# talk about a 'backup' we mean making a copy of the metadata for the
# *current* system. The 'archive' contains old metadata configurations.
# Backups are stored in a human readable text format.
backup {

    # Should we maintain a backup of the current metadata configuration ?
    # Use 1 for Yes; 0 for No.
    # Think very hard before turning this off!
    backup = 1

    # Where shall we keep it ?
    # Remember to back up this directory regularly!
    backup_dir = "/etc/lvm/backup"

    # Should we maintain an archive of old metadata configurations.
    # Use 1 for Yes; 0 for No.
    # On by default. Think very hard before turning this off.
    archive = 1

    # Where should archived files go ?
    # Remember to back up this directory regularly!
    archive_dir = "/etc/lvm/archive"

    # What is the minimum number of archive files you wish to keep ?
    retain_min = 10

    # What is the minimum time you wish to keep an archive file for ?
    retain_days = 30
}

# Settings for the running LVM2 in shell (readline) mode.
shell {
```

```
# Number of lines of history to store in ~/.lvm_history
history_size = 100
}

# Miscellaneous global LVM2 settings
global {
    library_dir = "/usr/lib"

    # The file creation mask for any files and directories created.
    # Interpreted as octal if the first digit is zero.
    umask = 077

    # Allow other users to read the files
    #umask = 022

    # Enabling test mode means that no changes to the on disk metadata
    # will be made. Equivalent to having the -t option on every
    # command. Defaults to off.
    test = 0

    # Whether or not to communicate with the kernel device-mapper.
    # Set to 0 if you want to use the tools to manipulate LVM metadata
    # without activating any logical volumes.
    # If the device-mapper kernel driver is not present in your kernel
    # setting this to 0 should suppress the error messages.
    activation = 1

    # If we can't communicate with device-mapper, should we try running
    # the LVM1 tools?
    # This option only applies to 2.4 kernels and is provided to help you
    # switch between device-mapper kernels and LVM1 kernels.
    # The LVM1 tools need to be installed with .lvm1 suffices
    # e.g. vgscan.lvm1 and they will stop working after you start using
    # the new lvm2 on-disk metadata format.
    # The default value is set when the tools are built.
    # fallback_to_lvm1 = 0

    # The default metadata format that commands should use - "lvm1" or "lvm2".
    # The command line override is -M1 or -M2.
    # Defaults to "lvm1" if compiled in, else "lvm2".
    # format = "lvm1"
```



```
# Location of proc filesystem
proc = "/proc"

# Type of locking to use. Defaults to local file-based locking (1).
# Turn locking off by setting to 0 (dangerous: risks metadata corruption
# if LVM2 commands get run concurrently).
# Type 2 uses the external shared library locking_library.
# Type 3 uses built-in clustered locking.
locking_type = 1

# If using external locking (type 2) and initialisation fails,
# with this set to 1 an attempt will be made to use the built-in
# clustered locking.
# If you are using a customised locking_library you should set this to 0.
fallback_to_clustered_locking = 1

# If an attempt to initialise type 2 or type 3 locking failed, perhaps
# because cluster components such as clvmd are not running, with this set
# to 1 an attempt will be made to use local file-based locking (type 1).
# If this succeeds, only commands against local volume groups will proceed.
# Volume Groups marked as clustered will be ignored.
fallback_to_local_locking = 1

# Local non-LV directory that holds file-based locks while commands are
# in progress. A directory like /tmp that may get wiped on reboot is OK.
locking_dir = "/var/lock/lvm"

# Other entries can go here to allow you to load shared libraries
# e.g. if support for LVM1 metadata was compiled as a shared library use
# format_libraries = "liblvm2format1.so"
# Full pathnames can be given.

# Search this directory first for shared libraries.
# library_dir = "/lib"

# The external locking library to load if locking_type is set to 2.
# locking_library = "liblvm2clusterlock.so"
}

activation {
    # Device used in place of missing stripes if activating incomplete volume.
    # For now, you need to set this up yourself first (e.g. with 'dmsetup')
    # For example, you could make it return I/O errors using the 'error'
    # target or make it return zeros.
```

```
missing_stripe_filler = "/dev/ioerror"

# How much stack (in KB) to reserve for use while devices suspended
reserved_stack = 256

# How much memory (in KB) to reserve for use while devices suspended
reserved_memory = 8192

# Nice value used while devices suspended
process_priority = -18

# If volume_list is defined, each LV is only activated if there is a
# match against the list.
# "vgname" and "vgname/lvname" are matched exactly.
# "@tag" matches any tag set in the LV or VG.
# "@*" matches if any tag defined on the host is also set in the LV or VG
#
# volume_list = [ "vg1", "vg2/lvol1", "@tag1", "@*" ]

# Size (in KB) of each copy operation when mirroring
mirror_region_size = 512

# 'mirror_image_fault_policy' and 'mirror_log_fault_policy' define
# how a device failure affecting a mirror is handled.
# A mirror is composed of mirror images (copies) and a log.
# A disk log ensures that a mirror does not need to be re-synced
# (all copies made the same) every time a machine reboots or crashes.
#
# In the event of a failure, the specified policy will be used to
# determine what happens:
#
# "remove" - Simply remove the faulty device and run without it. If
#           the log device fails, the mirror would convert to using
#           an in-memory log. This means the mirror will not
#           remember its sync status across crashes/reboots and
#           the entire mirror will be re-synced. If a
#           mirror image fails, the mirror will convert to a
#           non-mirrored device if there is only one remaining good
#           copy.
#
# "allocate" - Remove the faulty device and try to allocate space on
#              a new device to be a replacement for the failed device.
#              Using this policy for the log is fast and maintains the
#              ability to remember sync state through crashes/reboots.
```

```
# Using this policy for a mirror device is slow, as it
# requires the mirror to resynchronize the devices, but it
# will preserve the mirror characteristic of the device.
# This policy acts like "remove" if no suitable device and
# space can be allocated for the replacement.
# Currently this is not implemented properly and behaves
# similarly to:
#
# "allocate_anywhere" - Operates like "allocate", but it does not
# require that the new space being allocated be on a
# device is not part of the mirror. For a log device
# failure, this could mean that the log is allocated on
# the same device as a mirror device. For a mirror
# device, this could mean that the mirror device is
# allocated on the same device as another mirror device.
# This policy would not be wise for mirror devices
# because it would break the redundant nature of the
# mirror. This policy acts like "remove" if no suitable
# device and space can be allocated for the replacement.

mirror_log_fault_policy = "allocate"
mirror_device_fault_policy = "remove"
}

#####
# Advanced section #
#####

# Metadata settings
#
# metadata {
# Default number of copies of metadata to hold on each PV. 0, 1 or 2.
# You might want to override it from the command line with 0
# when running pvcreate on new PVs which are to be added to large VGs.

# pvmetadatasize = 1

# Approximate default size of on-disk metadata areas in sectors.
# You should increase this if you have large volume groups or
# you want to retain a large on-disk history of your metadata changes.

# pvmetadatasize = 255
```

```
# List of directories holding live copies of text format metadata.
# These directories must not be on logical volumes!
# It's possible to use LVM2 with a couple of directories here,
# preferably on different (non-LV) filesystems, and with no other
# on-disk metadata (pvmetadatacopies = 0). Or this can be in
# addition to on-disk metadata areas.
# The feature was originally added to simplify testing and is not
# supported under low memory situations - the machine could lock up.
#
# Never edit any files in these directories by hand unless you
# you are absolutely sure you know what you are doing! Use
# the supplied toolset to make changes (e.g. vgcfgrestore).

# dirs = [ "/etc/lvm/metadata", "/mnt/disk2/lvm/metadata2" ]
#}

# Event daemon
#
# dmeventd {
# mirror_library is the library used when monitoring a mirror device.
#
# "libdevmapper-event-lvm2mirror.so" attempts to recover from failures.
# It removes failed devices from a volume group and reconfigures a
# mirror as necessary.
#
# mirror_library = "libdevmapper-event-lvm2mirror.so"
#}
```

Appendix C. LVM Object Tags

An LVM tag is a word that can be used to group LVM2 objects of the same type together. Tags can be attached to objects such as physical volumes, volume groups, and logical volumes. Tags can be attached to hosts in a cluster configuration. Snapshots cannot be tagged.

Tags can be given on the command line in place of PV, VG or LV arguments. Tags should be prefixed with @ to avoid ambiguity. Each tag is expanded by replacing it with all objects possessing that tag which are of the type expected by its position on the command line.

LVM tags are strings using [A-Za-z0-9_+.-] of up to 128 characters. They cannot start with a hyphen.

Only objects in a volume group can be tagged. Physical volumes lose their tags if they are removed from a volume group; this is because tags are stored as part of the volume group metadata and that is deleted when a physical volume is removed. Snapshots cannot be tagged.

The following command lists all the logical volumes with the database tag.

```
lvs @database
```

1. Adding and Removing Object Tags

To add or delete tags from physical volumes, use the --addtag or --deltag option of the pvchange command.

To add or delete tags from volume groups, use the --addtag or --deltag option of the vgchange or vgcreate commands.

To add or delete tags from logical volumes, use the --addtag or --deltag option of the lvchange or lvcreate commands.

2. Host Tags

In a cluster configuration, you can define host tags in the configuration files. If you set hosttags = 1 in the tags section, a host tag is automatically defined using the machine's hostname. This allow you to use a common configuration file which can

be replicated on all your machines so they hold identical copies of the file, but the behavior can differ between machines according to the hostname.

For information on the configuration files, see [Appendix B, The LVM Configuration Files](#).

For each host tag, an extra configuration file is read if it exists: `lvm_hosttag.conf`. If that file defines new tags, then further configuration files will be appended to the list of files to read in.

For example, the following entry in the configuration file always defines `tag1`, and defines `tag2` if the hostname is `host1`.

```
tags { tag1 { } tag2 { host_list = ["host1"] } }
```

3. Controlling Activation with Tags

You can specify in the configuration file that only certain logical volumes should be activated on that host. For example, the following entry acts as a filter for activation requests (such as `vgchange -ay`) and only activates `vg1/lvol0` and any logical volumes or volume groups with the `database` tag in the metadata on that host.

```
activation { volume_list = ["vg1/lvol0", "@database" ] }
```

There is a special match `"@"` that causes a match only if any metadata tag matches any host tag on that machine.

As another example, consider a situation where every machine in the cluster has the following entry in the configuration file:

```
tags { hosttags = 1 }
```

If you want to activate `vg1/lvol2` only on host `db2`, do the following:

1. Run `lvchange --addtag @db2 vg1/lvol2` from any host in the cluster.
2. Run `lvchange -ay vg1/lvol2`.

This solution involves storing hostnames inside the volume group metadata.

Appendix D. LVM Volume Group Metadata

The configuration details of a volume group are referred to as the metadata. By default, an identical copy of the metadata is maintained in every metadata area in every physical volume within the volume group. LVM volume group metadata is small and stored as ASCII.

If a volume group contains many physical volumes, having many redundant copies of the metadata is inefficient. It is possible to create a physical volume without any metadata copies by using the `--metadatasize 0` option of the `pvcreate` command. Once you have selected the number of metadata copies the physical volume will contain, you cannot change that at a later point. Selecting 0 copies can result in faster updates on configuration changes. Note, however, that at all times every volume group must contain at least one physical volume with a metadata area (unless you are using the advanced configuration settings that allow you to store volume group metadata in a file system). If you intend to split the volume group in the future, every volume group needs at least one metadata copy.

The core metadata is stored in ASCII. A metadata area is a circular buffer. New metadata is appended to the old metadata and then the pointer to the start of it is updated.

You can specify the size of metadata area with the `--metadatasize` option of the `pvcreate` command. The default size is too small for volume groups with many logical volumes or physical volumes.

1. The Physical Volume Label

By default, the `pvcreate` command places the physical volume label in the 2nd 512-byte sector. This label can optionally be placed in any of the first four sectors, since the LVM tools that scan for a physical volume label check the first 4 sectors. The physical volume label begins with the string `LABELONE`.

The physical volume label contains:

- Physical volume UUID
- Size of block device in bytes

- NULL-terminated list of data area locations
- NULL-terminated lists of metadata area locations

Metadata locations are stored as offset and size (in bytes). There is room in the label for about 15 locations, but the LVM tools currently use 3: a single data area plus up to two metadata areas.

2. Metadata Contents

The volume group metadata contains:

- Information about how and when it was created
- Information about the volume group:

The volume group information contains:

- Name and unique id
- A version number which is incremented whenever the metadata gets updated
- Any properties: Read/Write? Resizeable?
- Any administrative limit on the number of physical volumes and logical volumes it may contain
- The extent size (in units of sectors which are defined as 512 bytes)
- An unordered list of physical volumes making up the volume group, each with:
 - Its UUID, used to determine the block device containing it
 - Any properties, such as whether the physical volume is allocatable
 - The offset to the start of the first extent within the physical volume (in sectors)
 - The number of extents
- An unordered list of logical volumes. each consisting of
 - An ordered list of logical volume segments. For each segment the metadata includes a mapping applied to an ordered list of physical volume segments or logical volume segments

3. Sample Metadata

The following shows an example of LVM volume group metadata for a volume group called myvg.

```
# Generated by LVM2: Tue Jan 30 16:28:15 2007

contents = "Text Format Volume Group"
version = 1

description = "Created *before* executing 'lvextend -L+5G /dev/myvg/mylv /dev/sdc'"

creation_host = "tng3-1"      # Linux tng3-1 2.6.18-8.el5 #1 SMP Fri Jan 26 14:15:21 EST
2007 i686
creation_time = 1170196095    # Tue Jan 30 16:28:15 2007

myvg {
  id = "0zd3UT-wbYT-IDHq-IMPs-EjoE-0o18-wL28X4"
  seqno = 3
  status = ["RESIZEABLE", "READ", "WRITE"]
  extent_size = 8192          # 4 Megabytes
  max_lv = 0
  max_pv = 0

  physical_volumes {

    pv0 {
      id = "ZBW5qW-dXF2-0bGw-ZCad-2RIV-phwu-1c1RFt"
      device = "/dev/sda"     # Hint only

      status = ["ALLOCATABLE"]
      dev_size = 35964301     # 17.1491 Gigabytes
      pe_start = 384
      pe_count = 4390 # 17.1484 Gigabytes
    }

    pv1 {
      id = "ZHEZJW-MR64-D3QM-Rv7V-Hxsa-zU24-wztY19"
      device = "/dev/sdb"     # Hint only

      status = ["ALLOCATABLE"]
      dev_size = 35964301     # 17.1491 Gigabytes
      pe_start = 384
    }
  }
}
```

```
        pe_count = 4390 # 17.1484 Gigabytes
    }

    pv2 {
        id = "wCoG4p-55Ui-9tbp-VTEA-jO6s-RAVx-UREW0G"
        device = "/dev/sdc" # Hint only

        status = ["ALLOCATABLE"]
        dev_size = 35964301 # 17.1491 Gigabytes
        pe_start = 384
        pe_count = 4390 # 17.1484 Gigabytes
    }

    pv3 {
        id = "hGIUwi-zsBg-39FF-do88-pHxY-8XA2-9WKliA"
        device = "/dev/sdd" # Hint only

        status = ["ALLOCATABLE"]
        dev_size = 35964301 # 17.1491 Gigabytes
        pe_start = 384
        pe_count = 4390 # 17.1484 Gigabytes
    }
}

logical_volumes {

    mylv {
        id = "GhUYSF-qVM3-rzQo-a6D2-o0aV-LQet-Ur9OF9"
        status = ["READ", "WRITE", "VISIBLE"]
        segment_count = 2

        segment1 {
            start_extent = 0
            extent_count = 1280 # 5 Gigabytes

            type = "striped"
            stripe_count = 1 # linear

            stripes = [
                "pv0", 0
            ]
        }
        segment2 {
            start_extent = 1280
            extent_count = 1280 # 5 Gigabytes
        }
    }
}
```

```
        type = "striped"
        stripe_count = 1    # linear

        stripes = [
            "pv1", 0
        ]
    }
}
}
```

Index

A

- activating logical volumes
 - individual nodes, 51
- activating volume groups, 31
 - individual nodes, 32
 - local node only, 32
- administrative procedures, 17
- allocation
 - policy, 27
 - preventing, 26
- archive file, 18, 33

B

- backup
 - file, 18
 - metadata, 18, 33
- backup file, 33
- block device
 - scanning, 24

C

- cache file
 - building, 30
- cluster environment, 3, 17
- CLVM
 - definition, 3
- clvmd daemon, 3
- command line units, 21
- configuration examples, 67
- creating
 - logical volume, 35
 - logical volume, example, 67
 - LVM volumes in a cluster, 17
 - physical volumes, 23
 - striped logical volume, example, 69
 - volume groups, 27

- creating LVM volumes
 - overview, 17

D

- data relocation, online, 50
- deactivating volume groups, 31
 - exclusive on one node, 32
 - local node only, 32
- device numbers
 - major, 41
 - minor, 41
 - persistent, 41
- device path names, 21
- device scan filters, 49
- device size, maximum, 28
- device special file directory, 28
- display
 - sorting output, 63
- displaying
 - logical volumes, 43, 59
 - physical volumes, 25, 55
 - volume groups, 28, 58

E

- extent
 - allocation, 27
 - definition, 9, 27

F

- failed devices
 - displaying, 79
- feedback, x, x
- file system
 - growing on a logical volume, 18
- filters, 49

G

- growing file system
 - logical volume, 18

H

help display, 22

I

initializing

partitions, 24

physical volumes, 23

Insufficient Free Extents message, 88

L

linear logical volume

converting to mirrored, 40

creation, 35

definition, 9

logging, 19

logical volume

administration, general, 35

changing parameters, 41

creation, 35

creation example, 67

definition, 1, 9

displaying, 43, 51, 59

exclusive access, 51

extending, 43

growing, 43

linear, 35

local access, 51

lvs display arguments, 59

mirrored, 38

reducing, 47

removing, 42

renaming, 42

resizing, 41

shrinking, 47

snapshot, 47

striped, 38

lvchange command, 41

lvconvert command, 40

lvcreate command, 35

lvdisplay command, 43

lvextend command, 43

LVM

architecture overview, 2

clustered, 3

components, 3, 7

custom report format, 51

directory structure, 28

help, 22

history, 2

label, 7

logging, 19

logical volume administration, 35

physical volume administration, 23

physical volume, definition, 7

volume group, definition, 9

LVM1, 2

LVM2, 2

lvmdiskscan command, 24

lvreduce command, 41, 47

lvremove command, 42

lvrename command, 42

lvs command, 51, 59

display arguments, 59

lvscan command, 43

M

man page display, 22

metadata

backup, 18, 33

recovery, 85

mirrored logical volume

converting to linear, 40

creation, 38

definition, 14

failure recovery, 81

reconfiguration, 40

O

online data relocation, 50

P

- partition type, setting, 23
- partitions
 - multiple, 8
- path names, 21
- persistent device numbers, 41
- physical extent
 - preventing allocation, 26
- physical volume
 - adding to a volume group, 28
 - administration, general, 23
 - creating, 23
 - definition, 7
 - display, 55
 - displaying, 25, 51
 - illustration, 7
 - initializing, 23
 - layout, 7
 - pvs display arguments, 55
 - recovery, 87
 - removing, 26
 - removing from volume group, 30
 - removing lost volume, 87
 - resizing, 26
- pvdisplay command, 25
- pvmove command, 50
- pvremove command, 26
- pvresize command, 26
- pvs command, 51
 - display arguments, 55
- pvscan command, 25

R

- removing
 - disk from a logical volume, 74
 - logical volume, 42
 - physical volumes, 26
- renaming
 - logical volume, 42

- volume group, 33
- report format, LVM devices, 51
- resizing
 - logical volume, 41
 - physical volume, 26

S

- scanning
 - block devices, 24
- scanning devices, filters, 49
- snapshot logical volume
 - creation, 47
- snapshot volume
 - definition, 15
- striped logical volume
 - creation, 38
 - creation example, 69
 - definition, 12
 - extending, 45
 - growing, 45

T

- troubleshooting, 79

U

- units, command line, 21

V

- verbose output, 21
- vgcfbackup command, 33
- vgcfrestore command, 33
- vgchange command, 31
- vgcreate command, 27
- vgdisplay command, 29
- vgexport command, 34
- vgextend command, 28
- vgimport command, 34
- vgmerge command, 33
- vgmknodes command, 35
- vgreduce command, 30

- vgrename command, 33
- vgs command, 51
 - display arguments, 58
- vgscan command, 30
- vgsplit command, 32
- volume group
 - activating, 31
 - administration, general, 27
 - changing parameters, 31
 - combining, 33
 - creating, 27
 - deactivating, 31
 - definition, 9
 - displaying, 28, 51, 58
 - extending, 28
 - growing, 28
 - merging, 33
 - moving between systems, 34
 - reducing, 30
 - removing, 32
 - renaming, 33
 - shrinking, 30
 - splitting, 32
 - example procedure, 71
 - vgs display arguments, 58